

STAR WARS®

Battle for the Golden Sun

An Adventure for use with *STAR WARS: The Roleplaying Game*

PLUS IMPERIAL
GARRISON PLANS



**WEST
END
GAMES**

On an unexplored water planet, warring natives, a missing Alliance dignitary, Imperial shock troops, and Rebel agents become entangled in the mystery of the Golden Sun.

STAR WARS®

Battle for the Golden Sun

by Douglas Kaufman

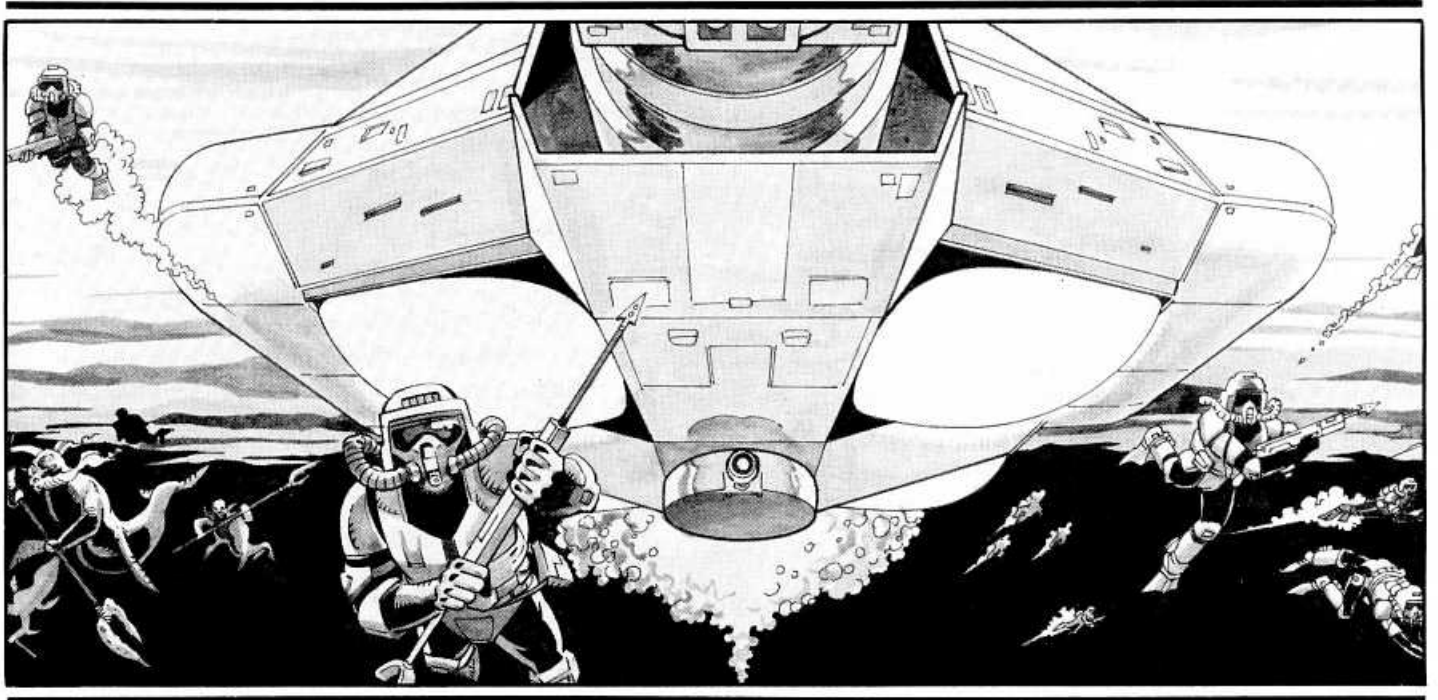

Development & Editing: **Bill Slavicsek** • Additional Editing: **Michael Stern** • Art Direction: **Stephen Crane**
Graphics: **Rosaria J. Baldari** and **Anne C. Fink** • Cover Art: **Greg Guler** and **James Bauer**
Interior Art: **Jeff Dee** • Map Art: **Stephen Crane** • Production: **Steve Porpora**
Assistance: **Jonatha Caspian, Peter Corless, Greg Gorden, Rob Jenkins, Martin Wixted**



RD 3 Box 2345
Honesdale, PA 18431
40017

I ntroduction

Swelling orchestral music rises up through a vast star field. A ship flashes past at high speed as the star field elongates and whirls crazily. The sound track reaches a crescendo, a planet pans into view, and another exciting episode of *Star Wars: The Roleplaying Game* begins. . .

Battle for the Golden Sun is a *Star Wars* adventure for two to six players plus a gamemaster. Gamemasters should read and become familiar with the adventure before beginning to play. Familiarity allows for fast action (in the spirit of the movies) with a minimum of page-flipping and undramatic pauses.

Players, on the other hand, should read no further. The information that follows is for gamemasters (GMs) only. Anyone who wishes to run a player character (PC) through this adventure will spoil the game for everyone by reading on. Knowing what's going to happen removes the suspense, surprise, and challenge necessary for the full enjoyment of *Battle for the Golden Sun*.

In This Adventure. . .

. . . a group of Rebels must travel to the Sedri system to rescue a missing Alliance dignitary and discover the secret of the mysterious Golden Sun. Whatever "Golden Sun" is, be it blazing star or alien device, the Alliance fears that it can be turned into an awesome weapon in the Empire's diabolic hands.

The Rebels take with them the only person to return from the dignitary's doomed mission, his Mon Calamari aide. But the aide did not return unscarred. Her mind, once sharp and quick, has become muddled and more than a little crazed. She rants about a "golden sun" and some strange happenings on a far away, watery world.

Though her words make little sense, they do coincide with recent Imperial communiqués which link the Golden Sun rumors with unexplored Sedri. What happened to the dignitary and his party on Sedri, what occurrence could be so frightening and traumatic as to leave his aide a gibbering wreck? The only clue may be the small green rock she clutches protectively to her breast.

Will the Rebels learn the secret of the Golden Sun? Can they rescue the missing dignitary, deal with an Imperial subjugation team, and keep a planetary disagreement from escalating into a civil war? These are the challenges that must be faced in *Battle for the Golden Sun*.

Preparing to Play

If this is your first *Star Wars* adventure, spend a few moments helping your players select and prepare their character templates according to the rules of *Star Wars: The Roleplaying Game*. Note, a Force-using PC will be extremely helpful in this adventure.

If this adventure is being run as part of an ongoing campaign, let your players use their existing characters. You may have to adjust the background or opening sequence to fit this adventure smoothly into your campaign setting.

Adventure Materials

In addition to the adventure booklet, *Battle for the Golden Sun* includes:

- *Star Wars Rules Upgrade*. This four-page folder contains important additions and clarifications for *Star Wars: The Roleplaying Game*.
- *The Pullout Section*. The four-page pullout section includes the script that starts the adventure, the maps of the city of Fitsay and the coral caves, the space boat handout, and the non-player character (NPC) templates.
- *The Full-Color Map*. This map details the interior and exterior of the Imperial Aquatic Garrison. The text tells you when to display it for your players.
- *Additional Materials*. Other items needed to play this adventure include *Star Wars: The Roleplaying Game*, pencils, paper, and lots of six-sided dice. *The Star Wars Sourcebook*, *The Star Wars Campaign Pack* (which features an updated gamemaster screen), and *Star Wars Miniatures Sets* are useful, but not necessary for play.

Difficulty Numbers and Game Balance

As GM, you must modify this adventure to fit your particular group of players. By using the *Difficulty Number Scale* found in the rules upgrade, this can be accomplished easily.

For example, if the text says that PCs must make Difficult *streetwise* rolls to accomplish a given task, turn to the "Difficulty Number Scale" in the upgrade. Assign a number between 16 and 20, depending on the level of skill of your PCs.

Attributes are capitalized and italicized, skills are only italicized.

Also keep in mind that the number of PCs and what template types they are using affects the outcome of each encounter. This adventure is designed for six beginning player characters with a good mix of skills. If you have fewer PCs, you may need to scale down the encounters accordingly. If your players have particularly strong characters, you may need to scale up the encounters to create sufficient challenges.

Adventure Background

Somewhere in the void lies the water world of Sedri. Virtually inaccessible to the hyperdrive-dependent technologies of the Old Republic and, later, the Empire, Sedri has remained isolated and unknown for centuries. A strange phenomenon, caused by one of Sedri's more unusual inhabitants, wreaks havoc upon hyperdrive instrumentation. Thus, ships which attempt to plot a course for the Sedri system via the hyperlanes find that their instruments refuse to comply. Astrogation computers register Sedri as one huge sun and, as most ships carry hyperdrive inhibitors to prevent headlong trips into raging stars, Sedri has remained undiscovered.

But, as is so often the case, a great discovery was made by accident. A small Imperial scout ship's hyperdrive inhibitor burned out during a jump near the Sedri system. The pilot noted the readings and also the failure of the inhibitor, and was sure he had only seconds to live before plunging into the center of a nuclear inferno. Instead, he found himself floating serenely in an unknown system, the third planet of which glowed with a radiant golden light. The scout noted the coordinates of the system and returned to known space with the news of his discovery.

But the planet and its inhabitants were oblivious to this event. The Sedrians, a humanoid seal people, have an advanced society based upon a technology totally alien to the Galactic Empire. In Fitsay, the largest of the Sedrian underwater cities, stands a sea-shell dome that is the center

of both religion and science on the water planet. For within the dome is the legendary coral — or sun — caves, home of the substance called Golden Sun. Here the Sedrians worship the golden sun coral and use its powers to energize their weapons and machinery.

Recently, a group of renegade Sedrians, led by the charismatic but power-hungry Karak, stole a small bit of Golden Sun. While preaching for distribution of Golden Sun to all citizens, Karak planned to use the powers of the stolen coral to overthrow the Fitsay priests. Cardo, the high priest of Fitsay, was furious. He sent his warrior monks to drive the renegades out. Karak and his followers fled into the vastness of the sea, taking their piece of Golden Sun with them. Claiming religious persecution and violations of his people's rights, Karak stirred the unrest to a boiling kettle of revolution. Then the off-worlders arrived.

Recent Events

The Imperials, while intrigued by their scout's report, were understandably reluctant to disengage their hyperdrive inhibitors before making jumps to the Sedri system. Unwilling to risk ships or large amounts of material, they authorized only small expeditions to Sedri. Without inhibitors there have been some lost ships, but those that did arrive quickly started to establish an Imperial presence with the construction of a garrison base, under the command of a ruthless officer named Aban.

Meanwhile, a young Alliance dignitary and his faithful retainer, busy recruiting and securing supplies for the Rebellion, began to hear rumors of a new Imperial garrison on a strange and remote water-world. Mors Odrion and his Mon Calamari companion Re kara decided to get more directly involved in the war effort. Full of youthful daring and adventurous spirit, Mors and Re kara set course for Sedri.

Fearful of the readings their astrogation computer spit out, they were relieved when they arrived safely at the water world. They found a world with glowing golden seas — as if a golden sun was submerged beneath the waves. Hiding the ship in a rocky cove, Mors and Re kara dove into the luminous sea. While they searched for the source the glow faded, and Mors and his companion were captured by Karak's renegades.

Using the powers of his small piece of Golden Sun, Karak stole information directly from Mors Odrion's mind. In this way, Karak learned about the Rebellion, the Empire, and the dignitary's mission. While Mors was constantly under guard, Re kara was basically left alone in a locked chamber. She escaped easily while no guards were

present. She knew she could not free her friend, but she could take away the item that caused him so much pain. She ripped the piece of coral from the ocean floor and fled to their hidden ship. But the cry of the dying coral, echoing deep within her mind, drove the Mon Calamari insane. Still, she lifted off and jetted away to seek help, clutching the now-dead coral to her breast.

Adventure Synopsis

The Rebel party is sent to Sedri to recover Mors Odrion, investigate any Imperial activity, and learn what Golden Sun actually is. On Sedri, the Imperial garrison nears completion. Karak, with a captured Alliance dignitary in tow, plans to deal with the Imperials for a half-share of the Fitsay sun caves. Properly used, Golden Sun should be able to hide Imperial fleets and planets the same way it hides Sedri from Galactic technology. With such an ability, the Empire would quickly be able to crush the unsuspecting Rebellion.

With the half-sane Rekara as a “guide,” the PCs must unite the two Sedrian factions in time to face the impending Imperial attack. Then, to rescue Mors Odrion, they must confront Karak himself in the depths of the sun caves.

The Main NPCs

Here are brief explanations of the major non-player characters and what their plans and motivations are. More information is available in the various episodes, and in the pullout sections.

Karak: Karak is a renegade Sedrian. He preaches reform and freedom, but is actually interested in power. Charismatic and evil, he has convinced his followers to live apart from the other Sedrians in their own community. Karak’s ultimate plan is to breed revolution against the priests of Fitsay, break into the sun caves, and gain the powers of the Golden Sun for himself. Karak was fortunate to capture Mors Odrion, as the Alliance dignitary gives him a perfect bargaining chip to use with the newly-arrived Imperials. Karak plans to gain Imperial aid if he can, or to pay tribute to the Empire if necessary — as long as he gets the power he craves. He has limited Force powers which he attributes to the Golden Sun. His only weaknesses are his daughter Fala and his faithful Razort pet, Tooch. It’s sometimes difficult to tell which he loves more. See the pullout for more about Karak.

Cardo: Cardo, high priest of Fitsay, is a peaceful, happy Sedrian. He is devoted to the Sedrian religion and takes his role as caretaker of the sun

caves very seriously. But Karak, though he does not believe his own preachings, is correct in his complaints: Cardo does want to keep the Golden Sun hidden and apart from the people. He believes that the commoners must not be allowed direct contact. He also refuses to treat the coral as the living, intelligent being it is, keeping it a prisoner within a sea shell dome. He doesn’t understand Karak’s grievances, or how much of a threat the Imperials are, or how to deal with them. He just wishes to lead his people quietly and study the mysteries of the Golden Sun, which he is teaching to his son, Pek. Like Karak, he has limited Force abilities. See episode two for more information.

Pek: Pek is High Priest Cardo’s son, a noble leader of the Fitsay people and a priest in his own right. As such, his main interest is in preserving the customs of his people, and in assuring that the Golden Sun shines forever. He is friendly, curious, and open to new ideas. He once shared a romance with Fala, which will rekindle at first sight. See the pullout and episode one for more information on Pek.

Fala: Fala, Karak’s daughter, is everything her father claims to be but isn’t. She is mostly unaware of what her father’s plans are, and she truly believes that the Sedrian society must change. She is willing to listen to reasonable arguments, but is very impatient with stupidity or prejudice. She will also remember her feelings for Pek after she sees her father’s true colors. See episode four for details about Fala.

Rekara: Rekara is an important part of this adventure: she accompanies the PCs to Sedri and provides hints during the course of the story. However, she is suffering from shock, caused by the death of the coral she carries with her. The death screams of the living polyps still echo deep within Rekara’s soul, and she is only lucid part of the time. See the adventure background, the pullout, and episode one for all the details about Rekara.

Commander Aban and his Seatroopers: Aban has orders to get the Imperial garrison constructed and running as quickly as possible. His problems are that he is understaffed, undersupplied, virtually cut off from the rest of the Empire, and under pressure to secure the Golden Sun without delay. Luckily, he does have a platoon of special aquatic stormtroopers — the seatroopers — to provide the muscle he’ll need when he confronts the natives. See the pullout section and episode three for more information.

E

pisode One

Crash on Sedri

Summary

The adventure begins with the Rebels on their way to the water world Sedri, accompanied by the crazed Mon Calamari, Rekara. They have been sent to rescue her friend and associate, the Alliance dignitary Mors Odrion. They arrive at Sedri after a harrowing ride, crash landing atop the watery surface. But before they can assess their situation, the Rebels find themselves in the heat of battle as Imperial troopers attack a lone Sedrian.

Read Aloud

A long time ago, in a galaxy far, far away. . .

A navigational accident has led the Empire to the mysterious and legendary water world, Sedri. Recent communiques, intercepted by the Alliance spy network, hint at increased Imperial activity on this unexplored planet. There have also been reports of a potential weapon source, something referred to as "Golden Sun." The reports, if they can be believed, claim that with this unknown weapon the Empire can quickly and utterly destroy the Rebellion.

When Alliance dignitary Mors Odrion heard these rumors, he took it upon himself to investigate Sedri. He never returned. His aide, the Mon Calamari named Rekara, did find her way back to a base — but whatever befell the two has driven Rekara insane.

Now Rekara, muttering on about "Golden Sun," accompanies a team of Rebel agents to the mysterious water planet. They must recover the missing dignitary and discover the secret of this new "weapon" before the Empire has a chance to use it against the Alliance. This group could be all that stands between the Empire and total control of the Galaxy. . .

Start the Adventure

Find the script in the pullout section and assign each player a part. The parts are labelled "1st Rebel," "2nd Rebel," and so forth. If you have six players, each player reads one part. If you have fewer players, assign additional parts to each as necessary. You must read the "Read Aloud" first, as it opens the scene in the script.

Pass out copies of the script and the space boat handout. Give everyone a chance to look over the handout and decide where they are aboard the ship, then start the read aloud. When you finish, point to the player assigned the part of "1st Rebel." He or she starts reading the script aloud. When the script is finished, pick up the action with "The Plunge" below.

The Plunge

When the players finish the script, read the following passage out loud.

There's one awful second when you're sure you're going to die . . . then an alarm starts whooping somewhere, and you drop out of hyperspace. You do not instantly disintegrate in a blazing inferno. Instead, you're floating in space above a water-world. The surface of the world is completely covered with green oceans — you can't see any land. Then, as you watch, a small golden spot appears in the ocean, and grows at a tremendous rate until the entire planet gleams gold! Rekara makes a strange gurgling sound. Then another alarm cuts in and your ship starts plunging toward the planet's surface.

Ask for *Perception* rolls from all PCs. Anyone making an Easy difficulty roll notices that a severe power surge has cut out the ship's engines. Those making Moderate rolls can trace the surge to the planet below. A wave of energy spread up from the surface, knocking out the computers controlling the ship's systems.

The PCs' first order of business should be trying to bring the ship under control. Have the PC piloting the ship make a *starship piloting* roll. The pilot can glide the powerless ship to a landing,

T he Planet Sedri

If the PCs seek information on Sedri from their computer, they will run into a few problems. Very little data is available about the planet or its system. It was visited once several hundred years ago by a Republic sublight survey Droid. A report was logged and then Sedri was forgotten. Recently, Imperial communiques have mentioned the planet, spurring rumors across the galaxy. And, of course, the Mon Calamari named Rekara claims to have returned from there.

If scanned, and the PCs make an Easy *planetary systems* roll, Sedri is confirmed to have an environment that is safe for all known races. There are no large land masses evident, though small islands dot the surface here and there. Readings indicate a sophisticated technological installation, probably Imperial in nature, some distance from the point where the PCs' vessel lands. There are also indications of a power source that is unlike anything used in the known galaxy, but the area of concentration cannot be pin-pointed unless scanned while the sea glows. Finally, there are the gravity-wave readings — they are completely incomprehensible, suggesting that Sedri is far more massive than it could possibly be. It seems that these gravity waves cause power surges in hyperspace and sublight drives and greatly reduce the range of com units, but have little to no effect upon repulsorlift engines.

In addition to this information, the PCs also have access to the data provided by Rekara during her less-crazed periods. She told commanders back at the base about an intelligent race of "seal people" living beneath the golden waves. She also mentioned "Golden Sun," but refused to elaborate on what that might be.

Force-using PCs who make a Difficult *Sense* or *Perception* roll feel a presence in the Force that seems to call out to them. It doesn't feel as though it is a hostile presence, but it is infinitely melancholy. The presence disappears when the PCs crash, fading as the golden glow fades. Force-using PCs who don't make the roll feel sad and gloomy for no apparent reason, but the feeling fades shortly after landing on Sedri.

but the rate of success depends on how well the PC rolls.

A Very Easy roll crashes the ship into the water, damaging the hull beyond the ability of the PCs to repair. They're safe, but they'll need to find another way off planet (perhaps by stealing a vessel from the Imperial garrison). An Easy roll brings the ship in hard, but the damage can be repaired with a Moderate *starship repair* roll. A Moderate roll or better allows the pilot to coast in safely.

The PCs could instead decide to bail out of their plummeting craft. Give them an opportunity to grab glider-sails and leap out while you build the drama and suspense of the moment by describing the scene. PCs must make Moderate *jumping* and Easy *Dexterity* rolls to safely leap from their ship and land the glider-sails in the water. They can return to their ship after it crashes to gather other supplies, but the ship itself will be useless. The damage it suffers in the unguided crash is too great for the PCs to repair. They will need to find another ship to leave Sedri when they finish their mission.

Use the following passage, modified by whether the PCs are inside or outside the ship, to end this sequence.

The surface of the planet suddenly fills your viewport as your ship plunges toward Sedri. Crashing golden waves throw brilliant light in every direction. After a moment, all you can see is gold. Rekara cries out from somewhere nearby as the bright golden glow suddenly winks out and the waves turn green. Then the ship smacks the water, hard!

There's a sound like a sonic boom, and the ship tosses from side to side. The lights flicker, dim, then come back on. You hear no sounds at all for a second, then the ship jumps up like a broken turbolift, and you find yourselves floating on Sedri's surface.

After the Plunge

Regardless of what kind of piloting roll the PCs made, the power surge and the subsequent crash landing have taken a toll on the Rebels' craft. At best, the PCs can get the ship to work in its water-vessel mode, providing them with the capacity to travel atop the waves or beneath the surface. But the hyperdrive and sublight motivators have burned out, and the power cells for those engines are dead. Before the ship can lift off into space it will need a significant energy boost to power up the blown cells.

Describe the gentle seas lapping at their ship as the PCs try to reorganize themselves. While the PCs take stock of their situation, use the cut-away below to get them moving. A cut-away is a cinematic technique that we've borrowed right from the *Star Wars* movies. This cut-away scene doesn't directly involve the PCs but sets up situations that must be resolved during the adventure.

Cut-Away to Imperial Aquatic Garrison

Read aloud:

EXTERIOR: SEDRI, IMPERIAL AQUATIC GARRISON. *The base, gleaming white in the sun, rises like an iceberg from a serene ocean. The camera moves closer to the base at high speed, passing through an opening blast door to reveal. . .*

INTERIOR: GARRISON BASE. *Everything is very new. The camera moves down sparsely populated corridors, past two Droids and a technician working at an open access panel. Up a turbolift, then a door marked "Commander Aban" comes into view. Closer, and the door opens.*

"Report, lieutenant!" *snaps Aban.*

"We've sent out patrols to search the native villages, sir," *the unseen lieutenant replies.* "Stories abound, but nothing solid yet."

"And the Swimmer?" *Aban's eyes gleam.*

"It arrived with the last shipment, sir."

"Perfect." *Aban stands triumphantly.* "If you do not find this Golden Sun by the time the Swimmer is operational, we will raze the Sedrian villages one at a time until they give it to us! You have your orders."

Fade to. . .

INTERIOR: REBEL SPACE BOAT EXPLORER.

Look around expectantly, then ask the players what they want to do.

Seatrooper Encounter

In the distance, a group of specialized aquatic stormtroopers, called "seatroopers," battle a lone Sedrian. This is Pek, son of Cardo, high priest of Fitsay. He becomes a key character in the unfolding adventure after the PCs save him from the Imperials.

As the PCs go to investigate the sounds and sights described above, they come upon the "Desperate Battle" below. If they try to do this while staying in *Explorer*, point out how slowly they're travelling due to the damage the ship sustained. They should decide to use the speeder-rafts in the ship's stores, but if they continue to travel in the space boat Pek will be wounded by the time they arrive (see below).

Note, because of the damage caused by the crash, the ship's nav computer is non-functional. No navigational coordinates can be programmed, no mapping programs can be initiated, and the ship must be driven manually. If they ignore the battle and drive around, they won't find anything — after all, it's a big planet.

Rekara's Rock

Rekara clutches a small greenish rock in her hand and will not let it go no matter what; there will be much screaming and kicking if someone tries to take it away. If she is subdued, she will pester whoever has the rock until they give it back.

The rock is actually an inert piece of Golden Sun, the strange substance that everyone is looking for. Don't reveal this to the PCs until the adventure says to, even if they figure it out on their own.

Analysis of the rock reveals that it is some sort of coral configuration, but yields no other information. A Force user who specifically tries will detect slight life emanations from the lump, provided he or she makes a Moderate *Sense* roll. This particular piece of Golden Sun, when ripped from its coral bed, projected its intense fear and pain directly into Rekara's soul. It did not mean to harm her, but the effect has driven the Mon Cal insane. Now the coral is in hibernation trance, trying to sustain its life until it can be returned to Sedri.

First Clash

Let the players have a chance to assign equipment and decide on a tentative course of action, but don't let them dither too long. If they seem uncertain as to what to do, move things along a little faster — remember, cinematic speed, action, and quick cuts are necessary for all *Star Wars* adventures. After a few minutes of planning and discussion, interrupt them with the following read aloud:

You notice several white dots about six hundred meters away to the southeast. A bellowing roar reaches you faintly, and you think you hear the sound of blaster fire.

Desperate Battle

As the PCs come to investigate the firing and bellowing, they see a strange sight. Read the following aloud:

You see five seatroopers on waveskimmers — small, one-man repulsorcraft — swirling around a rock outcropping which juts a few feet from the sea. In the rocks, pinned down by the seatroopers' fire, is a huge seal-like creature with a humanoid upper torso and head. He wears some sort of headband or crown. He bellows with fear and anger as the seatroopers close in.

Note: If your PC group consists of four or fewer players, lower the number of seatroopers to three.

Presumably the PCs will come to the aid of the beleaguered Sedrian, Pek, and battle the seatroopers. If Pek is unwounded, he joins in the battle as best he can, swimming powerfully through the water to upset one of the waveskimmers at a dramatically appropriate moment.

Statistics for Pek and the seatroopers can be found in the pullout section.

The Seatroopers' Tactics: In the first round of combat, the seatroopers announce enough multiple shots to cover all visible PCs. They do this to get the PCs to duck, thus testing their dodge abilities. In the second and subsequent rounds two combine fire at the most dangerous-looking PC, determined by who performed the best dodge, and the other hurls concussion grenades in the general direction of the PCs' vehicle. As soon as there is only one seatrooper left, he will cut and run for the Imperial base.

Waveskimmers: Speed Code 3D, Maneuverability 2D+1, Body Strength 1D+2.

Meeting Pek

After the last seatrooper has been defeated, the PCs have a chance to talk with the Sedrian, Pek. Even though they rescued him, Pek is a bit wary of the alien strangers. Let the PCs roleplay the meeting, doing their best to convince the Sedrian of their good intentions.

Once cordial relations are started, Pek describes how the Imperials began arriving not too long ago in small ships, and how they have been building their installation and killing the local sea life. He was scouting the installation on behalf of his father, High Priest Cardo of Fitsay, when the seatroopers attacked him. He knows the location of the base, but demands that the PCs accompany him to Fitsay first.

Battles On and In the Sea

Whenever you have a chase or battle scene in *Star Wars: The Roleplaying Game* you have to use a fine balance of rules, dice, and exciting, pell-mell description. Don't get too hung up on the exact numbers and rules necessary. Especially in chase scenes, half the fun can be in describing the way the skimmers slam into the waves, and the stinging spray mixed with the flying blaster bolts as everyone zooms about.

When fights occur underwater, keep the following tactics and tips in mind:

- Lightsabers don't work well under water. They boil up ocean and spin around, requiring a Moderate *Control* or Difficult *Dexterity* roll to hold onto or pick up.
- PCs use their *swimming* codes (plus one die) for movement and dodging. Seatroopers use their base *swimming* code.
- When a grenade goes off underwater, it does 4D damage to everyone within its entire range. The victim at close range can be wounded, but all others take stun damage only (see the sidebar on stun damage). This is because water is a tremendous conductor of concussion waves.
- Blasters are not as effective underwater. The difficulty of any blaster shot is increased by one level, and the blaster does 2D less damage.
- The bottom of the sea is usually covered with fine silt. If anyone runs his propulsion unit very close to the sea bottom, it creates a cloud to hide in. The common seatrooper response to this is to toss a grenade into the cloud to blow the silt away.

The Next Step

The Rebels should choose to accompany Pek to Fitsay, especially since he promises to take them to the "fish-killers" after he reports in to his father. If they refuse his offer, Pek returns with enough warrior monks to stun the PCs and bring them back to the city as prisoners.

If the PCs want to make ship repairs before proceeding, go ahead and allow them to begin, but they will discover that they don't have a power booster to restart the ship's cells.

Whether they go to Fitsay as Pek's friends or prisoners, the PCs now proceed to episode two.



Sedrian Language

When the PCs meet Pek, have everyone make a *language* roll. PCs who make an Easy roll understand pidgin Sedri — most words, punctuated by an occasional bark or whistle. A Moderate roll allows the PC to communicate (and automatically translate for the others) unhindered, except for certain key phrases. A Difficult roll means the Rebel understands everything that's being said.

Below is a short list of common Sedrian idioms; you are encouraged to add to the list. Envision the sort of special words or phrases a marine race might develop. The more colorful the Sedrian are, the more interesting the adventure will be for your players.

To Coral: To relieve a minor annoyance; from the Sedrian habit of scratching their skin on coral growths. In usage, "The Imperials think to just coral us, then take what they want."

Dark Water: Water at 50-100 meters depth; from the fact that water at this depth absorbs so much light that vision is practically useless.

Deep Enough That Only the Bubbles Rise: In very serious trouble.

Fish-Killers: The Imperials.

Full Fluke or Full Blow: To make a maximum effort.

Hiding Water: Water layered with differing temperatures. Such water baffles the senses of many predators which hunt the Sedrians, including Imperial probe Droids!

Strong-Stroke: A unit of distance, approximately 400 meters.

Thinks With His Flippers: Prone to rash acts, preferring quick over deliberate action.

Whiskerback Time: To swim or run at top speed at the cost of extra sensory loss from flattened whiskers.

E

pisode Two

The City of Fitsay

Summary

In this episode, the PCs explore the Sedrian city of Fitsay, then meet and negotiate with High Priest Cardo over the location of the missing dignitary and the truth about Golden Sun. By the end of the episode the Rebels should have an idea of the Golden Sun's significance and be prepared to enter the Imperial garrison base with Pek's help.

Arriving at Fitsay

If the PCs go to Fitsay as Pek's friends, the first meeting with Cardo will be simple and cordial. If they arrive as Pek's prisoners, it takes some diplomatic discussion before Cardo trusts these strangers.

Assuming all goes well, Pek leads the Rebels to the underwater city. See the pullout section for the map of Fitsay. Show the players the map and read the following out loud as they approach the city.

Coming upon the city of Fitsay is like landing on a planet from space — it's as though you're making an aerial approach as you drop through the sparkling water. From above, the city looks fairly small. A large shell dome dominates the center of the area. To one side a bench-like structure rises up from the sandy bottom, and on the other a complex of interconnected stone buildings fill the watery depths. About half a kilometer to the northwest, the terrain begins to slope up toward mountainous peaks that form a sheer cliff wall further back.

You notice a commotion in what appears to be a marketplace. One Sedrian gathers a crowd about him as he shouts. "How dare this city regulate our lives! Should not the power be for everyone? Should not the community be free? Join Karak! Defy those who hold the power for themselves!" Before he can continue a group of warriors wade through the crowd, scattering it in all directions. They

raise weird rifles and fire beams of golden light at the speaker, stunning him into silence.

If the PCs come as friends, Pek escorts them immediately to the inn (area 3 on the map). He explains that the renegades must be controlled if peace is to be maintained. Go to "At the Inn" below.

If the PCs arrive as prisoners, they are welcomed cordially, if somewhat coldly, and then escorted to the audience hall (area 9). See "Coming Before the High Priest" below.

If they try to help the renegade, Pek turns against them. Send a large group of warrior monks to convince them to cease all hostile actions and escort them to the audience hall. If they decide to continue the battle, the monks use their stun weapons to knock them unconscious. The Rebels come to later in the audience hall, surrounded by monks and stripped of their weapons. Go to "Coming Before the High Priest" below.

The Sedrian People

The Sedrians are perfectly adapted to living on their watery planet. Basically humanoid seals, Sedrians have both lungs and gills. While more comfortable beneath the waves, the Sedrians can spend an unlimited amount of time in the open air.

A head, torso, and two arms with webbed fingers make up a Sedrian's upper body. The lower body consists of two stabilizing flippers and a tapering fluke instead of legs. The entire body is covered in smooth fur, and shaped to move these powerful swimmers efficiently through the water. The flippers can be used to clumsily navigate on land, but no other race is more graceful under the rolling waves.

Sedrians have deep, rumbling voices that project even through the watery silence. They bellow loudly when frightened or enraged. Their language includes weird combinations of grunts and barks, as well as some truly beautiful sounds that come close to song.

The Sedrians have a sophisticated technology based on the power supplied by Golden Sun. They employ strange-looking melee weapons (use normal melee weapon statistics) made from various shell fish, energy weapons, and spear guns. The typical energy weapon is the sun gun. This device resembles a long tube with a handle. Within the hollow tube rests a crystalized bit of coral, gathered from the coral caves, that has been energized by the power of the Golden Sun (see episode four for more information).

The people of the water planet live by the tenets of their religion. These beliefs center around the Golden Sun and are controlled by the high priest of Fitsay, keeper of the coral caves. They are peaceful and reflective, looking to the leader of the city to regulate their lives.

Cardo, the high priest, honestly believes he knows what is best for his people. His priests of the sun spread the tenets of peace, reflection, and community throughout the undersea villages, and tend to the coral caves within the Great Shell Dome. But when the words of peace are not enough, the warrior monks are ready to enforce the will of the high priest. Once these fierce protectors were controlled by Karak, bishop of war, but he has since become a renegade and lives apart from the community. Statistics for Karak are in the pullout section. Other stats are listed below.

High Priest Cardo: DEX 3D; dodge 4D; KNO 2D+2; bureaucracy 4D+2; MEC 1D+1; PER 3D; command 5D; STR 3D+2; swimming 6D+2; stamina 4D+2; TEC 2D+1; Con 1D; Sen 1D.

Priests of the Sun: DEX 1D+2, melee weapons 2D+2; KNO 2D+1; MEC 1D+1; PER 2D+2, bargain 3D+2; STR 2D+1, swimming 4D+1; TEC 1D+2, medicine 3D+2. The priests carry staves and wear ornate golden pins, engraved with a spiral coral pattern, over their left breast.

Warrior Monks: DEX 2D+1, spear gun 3D+2, sun gun 4D+1, melee weapons 3D+1, dodge 3D+2; KNO 1D+2; MEC 1D+1; PER 1D+2, command 3D+2, search 3D; STR 3D+2, swimming 6D; TEC 1D+1. The monks carry spear guns and sun guns

Citizens, Pilgrims, and Renegades: DEX 2D; KNO 1D+2; MEC 1D+1; PER 2D; STR 2D+2, swimming 3D+2; TEC 2D+1.

Weapon Damage: Sun gun 5D (stun damage only), spear gun 3D+2, melee spear STR+1D+1, melee staff STR+1D.

The typical tactic employed by warrior monks in combat is to fire the spear gun in the first combat round, then stun the opponent with shots from the sun gun. When the opponent is dazed

and uncertain, the attacker closes in with melee weapons. Cardo, a pacifist, orders his monks not to use spear guns unless absolutely necessary and to be sparing with melee combat.

At the Inn

The inn holds Sedrian pilgrims from all over the planet. The Rebels are provided with rooms and materials to refresh themselves with while they wait to be called to see the high priest. If the PCs speak to any of the Sedrians at the inn, the pilgrims explain that they have come to pay homage to the Golden Sun. If asked what Golden Sun is, the pilgrims simply smile knowingly and swim on.

While the PCs are waiting at the inn, have any Force-using Rebels make a *Sense* or *Perception* roll. If they make a Moderate roll, they again feel a presence in the Force calling to them. This time it projects loneliness and claustrophobia, making the Rebel experience these emotions in their rawest form. Then, as quickly as it manifested, the presence draws away. If the Force-using Rebels don't make the roll, they experience the powerful emotions without any sense of source or reason.

Then the Rebels get the call to appear before the high priest. Go to "Coming Before the High Priest" below.

Talking Underwater

The Sedrians speak with booming voices that can be heard under water. The Rebels wear breath masks with built-in comlinks for communicating among themselves. If they flip a switch, they can put their comlinks on speaker mode so that the Sedrians can hear them as well.

Coming Before the High Priest

If the PCs come as friends, after they have been given a chance to rest at the inn they are brought to the house of the high priest (area 8). Here, in this splendidly ornate house, they are led to a spacious chamber. A feasting area has been set to one side, fashioned with floating nets filled with seasoned fish, prepared water plants, and pickled crustaceans. After a brief wait, the high priest, accompanied by a lesser priest and a monk, swim into the chamber. See "High Priest Cardo" below.

If the PCs arrive as prisoners they are brought immediately to the audience hall. Under the supervision of a lesser priest, eight monks search the Rebels, removing all obvious weapons (blasters



and spear guns, but not grenades). After the priests are sure they have been rendered harmless (whether they have or not), they sound a great seashell horn that rises from the center of the hall. After a brief wait, the high priest swims into the chamber to a rousing fanfare. See "High Priest Cardo" below.

High Priest Cardo

As Cardo swims into the chamber, read the following section aloud:

The attending Sedrians give the arriving high priest a welcoming fanfare, singing in their great booming voices. The high priest is one of the largest Sedrians you've seen so far. He wears a heavy golden circlet on his head, inlaid with an ornate coral pattern. He settles atop a large rock that juts from the stone floor. You notice that the rock is located in a commanding position, giving the high priest a perfect view of the entire chamber. He looks you over with old, tired eyes, stroking his whiskers most deliberately.

If the PCs are here as friends, Cardo gestures for them to rest upon the nearby rocks. If they are here as prisoners, he keeps them swimming during the discussions to come. Make sure you are familiar with Cardo's background and his arguments below before attempting to run this scene. As the PCs begin to speak with Cardo, use the information to determine how the conversation proceeds. Remember, while Cardo believes what he says, it isn't necessarily true. Cardo has

specific things that he wants, and is willing to bargain for them — but he is also wary of giving too much away to people he doesn't know too well. Roleplay the entire scene, giving your players a chance to swing arguments in their favor or to totally mess up by saying the wrong thing. Keep the scene going as long as it's interesting, fun, and there is still something left to be gained.

Cardo's Arguments

On Karak and the Renegades: "Karak, once Fitsay's bishop of war, has misled a small segment of the population. He guides his renegades down a dark path away from the golden light. He is nothing but a thief, liar, and malcontent, spreading vicious lies in order to start a revolution. But we

S tun Damage

When blasters are set on stun, or when characters are attacked by weapons designated as "stun only," these rules are used. Note that these rules replace "Setting Blasters on Stun" on page 48 of *Star Wars: The Roleplaying Game*. Also note that weapons set on stun retain their normal damage codes, but use the table below for effect.

Stun Damage Summary

DR < SR	No effect
DR ≥ SR	1D Stun
DR ≥ 2xSR	2D Stun
DR ≥ 3xSR	Unconscious
DR	= damage roll
SR	= target's strength roll

All die codes (except Strength) are reduced by 1D for each stun. Stuns are cumulative within a round. For example, a character hit twice for a "2D stun" result each time would lose 4D for all actions in that round and the next round.

If the number of stuns taken in one round exceeds the character's Dexterity, that character is immobile. Immobile characters are not unconscious, but they can take no DEX skill actions while immobile. If they have dice remaining in any other attributes, however, they can take those types of actions. For example, a 3D stun total received in one round would immobilize a Scout character, but the Scout would still be able to use his Knowledge skills.

If the number of stuns ever exceeds a character's stamina, that character is knocked unconscious.

are the true guardians of the Golden Sun, providing its soothing light to all who desire it. Karak cares nothing for his people; he wants only personal power and control over the Golden Sun. I am saddened and confused by his actions. Perhaps you could help us avoid the inevitable bloodshed that arrives with the next wave." (Note, Cardo really believes that his way is better and that Karak is nothing more than a troublemaker. Karak is a troublemaker, but Cardo's policies are hurting the people in their own way.)

The Imperials: "The fish killers! Evil swims our seas, encased in shells and armed with powerful weapons. We must wait and see what the fish killers want before deciding a course of action. If we wait, they shall drift away with the rest of the flotsam. We must not take the violent path. We must trust to the mystery of the Golden Sun and let the oceans fend for themselves." (Note, Cardo can be convinced that the Empire is evil, but he will not commit his people to battle.)

Golden Sun: "You ask of golden seas, of Golden Sun. Of these things I cannot speak. Suffice it to know that I am the caretaker, the high priest, of Fitsay. The mysteries are for our people only, and not for strangers . . . no matter how good their intentions." (Note, Pek will argue that these people deserve the truth if they helped him earlier. However, at this point in the adventure Cardo cannot be swayed.)

Mors Odrion: "I know of no Alliance dignitary. I have never heard of Mors Odrion, or ever before seen the strange one you call Rekara. I do not know if the fish killers have your friend, but if they do that is not a concern of my people." (Note, Cardo has no idea where Mors Odrion is.)

Inevitable Questions: Almost invariably, a player will ask a question you do not know the answer to. You'll just have to wing it. As long as it sounds good and fits into the story, it fills all the necessary requirements. Be creative and let the story flow. That's what good GM-ing is all about.

Wandering Around Fitsay

After the discussion, Cardo bids goodnight and retires for the evening. If the PCs are now friends with the Sedrians, Pek suggests that they explore the city. He assures them that they will leave for the base in the morning. If the PCs make an Easy *cultures* roll (one roll necessary for each place they visit), give them all the information available; otherwise let them discover the information through the course of their visit.

1. Farms. On the outskirts of the city, fields of algae, seaweed and other water plants are

Cut-Away to Mors Odrion

Before this episode ends, read aloud:

INTERIOR: MORS ODRION'S CELL. *It is very dark — only a small beam of light illuminates the form of Mors Odrion, Alliance dignitary. He looks haggard and weak as he stares at the floor. "Rekara," he mutters, "I'm so sorry."*

The sound of his cell door being unlocked brings Odrion out of his reverie — his head snaps up and his eyes squint at the brighter light. "What now?" he asks his captor.

"Time for you to prove your value to the Empire," says a deep, rumbling voice. There is a clicking sound and Odrion's eyes widen in fear.

Fade to black. . .

cultivated by farmers. The farmers are cautious, suspicious, and unwilling to talk to the strangers. Many support Karak's teachings, but few are outspoken renegades. One young Sedrian swims through the fields, teaching Karak's philosophy. The Fitsay farms grow food, building material, medicine, and fodder for domesticated fish-herds.

2. Houses. These small one-story dwellings are home to the Fitsay citizens and farmers. Few can be found at home during the day.

3. The Inn. This large, three-story building is nearly full, as pilgrims from across the planet constantly visit the city for a chance to see Golden Sun. They will speak to the PCs in general terms, expounding the benefits of life in the light, but will never discuss specifics. In fact, few of these faithful know anything specific.

4. Marketplace. This is a sprawling section where the locals congregate to sell their wares. Stalls include shell-carving, hand-made weapons, sharkskin works, stones and gems, weaving, food (oysters, exotic seafood delicacies and so on), coral works (the coral-seller will not recognize the piece of Golden Sun, but will trade some beautiful items for it), and anything else you can think of. Make *bargain* rolls as appropriate to decide what items the PCs will have to trade to the shopkeepers. There is also a healer in the marketplace. This Sedrian uses a seaweed extract to treat *wounded* characters. She is not skilled enough to handle more serious injuries. Note, no energy weapons are available in the marketplace, but melee weapons are plentiful.

5. The Great Shell Dome. This intricately designed, giant structure is a dome made from interconnected sea shells. A special varnish renders the dome impervious to all but the most powerful ship-mounted weapons. More than 30 meters long and rising 15 meters over the sea bed, the dome can be seen from a distance. A Force user will detect strong emanations from within the dome. The PCs cannot gain entry into the dome at this point in the adventure. See episode four for more details.

6. Sacred Pews. From this tall stand of benches that overlooks the Great Shell Dome, Sedrians from all over can sit and contemplate the wonders of the Golden Sun. More pilgrims can be found in meditation here, awaiting the next opening of the dome.

7. Priest House. The Fitsay priests live and work in this ornate building.

8. High Priest House. Cardo's dwelling connects to the other major buildings in Fitsay. Monks guard the connecting tunnels to restrict unauthorized access. The high priest's home is an ornate structure with large chambers, airy lofts, and many lesser priests that service their leader.

9. Audience Hall. This large building consists of a central chamber that can hold vast numbers of Sedrians. The chamber contains many rocky outcroppings — the favorite resting spots for the aquatic people. Here, Cardo usually meets visitors or hears petitions from the Sedrian citizens.

10. House of War. While a peaceful people, the Sedrians know that they must be prepared to defend their cities and villages. The warrior monks

fill this niche in society. The House of War, once the home of Karak, the bishop of war, now lies empty. Only the monks still swim its spartan corridors, keeping it ready until the high priest chooses a successor. All manner of weapons and armor decorate the walls of this place of strength.

11. Warrior Monk Huts. These small, two-story chambers are sparsely furnished and rigid in design and function. Each provides living space for 10 monks. Six can usually be found here at any given time; the others are away on duty or otherwise engaged in another part of the city.

12. Guard Towers. These tall towers rise 30 meters over the city, allowing the guards to see in all directions. One monk occupies each tower within the city, while the towers outside the city hold two monks each. Large sea shell horns hang within the towers. These are used to signal other guards if trouble occurs. A tower consists of a covered platform that floats above the city atop two large air sacks. Long tethers anchor the platforms in place, made from a material of 4D body strength. The tether must be severely damaged to be disconnected. If disconnected, the tower platform quickly rises to the surface.

Sneaking Out

Early the next morning, Pek wakes the Rebels and tells them it is time to go. Read:

“My father has forbidden me from taking you to the fish-killers floating shell, but I must do what is right. Let us go find your friend.”

Go on to episode three.

E

pisode Three

Inside the Imperial Base

Summary

Led by the young Sedrian priest Pek, the Rebels find the Imperial base. Pek assists them in getting inside and they search for Mors Odrion. They find no sign of the dignitary, but other information concerning Imperial plans comes their way. The episode ends abruptly with the arrival of an Imperial supply shuttle and more troopers

This episode is constructed to allow the PCs to wander about the base in any way they wish. Events which must occur to drive the action forward are marked in the text.

The Map of the Imperial Aquatic Garrison

The full-color map of the Imperial aquatic garrison details the exterior and interior of a typical water-world base. This particular base is still under construction, so parts are unfinished or non-operational, but the map can be used any time you want to introduce an Imperial base into your *Star Wars* adventures. You can cover sections of the map with pieces of paper, revealing more and more as the PCs explore.

Because of the limited number of personnel on Sedri, the base is also underpopulated. As the PCs move through the corridors and walkways, give them the sense of being in a semi-deserted structure. Hollow echoes resound with each foot fall, and large areas of darkness fill the immense interior where the lights have not yet been activated.

Where are the Imperial Crowds?

The typical Imperial garrison base houses over 3,000 combat, command and support personnel. The Sedrian base has less than 250 people. Why?

Well, getting to Sedri in the first place is very hazardous. Of the three small scout vessels which were sent to Sedri in the first wave, only two arrived (the third, its hyperdrive inhibitor turned off, flew into a rogue planetoid and was demolished). Thus, the Imperial authorities are reluctant to send much in the way of equipment and

personnel to Sedri — at least not all at one time. Right now, only the first two waves of a proposed four-wave expedition have arrived. The third wave is coming shortly. The fourth wave won't arrive for months.

As the PCs wander about the base, you can mention the environment. If they are aware of the details surrounding travel to Sedri, and make Moderate *bureaucracy* rolls (to figure out how the Imperial mind would react to such a situation), you may also confirm any theories they come up with.

The Base from Outside

This structure looks exactly like a typical Imperial garrison base, except that the lower level isn't underground — it's under water! This aquatic base, using the basic design of the modular garrison, has certain modifications for better use in a water environment. Refer to the descriptions



below when describing the base to the PCs. Only those areas that are finished are described; other areas mentioned on the map have yet to be constructed.

Blast Doors. On a land base, the blast doors are at ground level and permit entry to ground vehicles. On this base, the doors extend beneath the water. A flotation collar wraps around the base, keeping the garrison atop the green waves. The doors open to the ocean to launch wave-skimmers and other ships from the vehicle bay.

Docking Station. The docking station is used not for AT-AT Walkers, but for AT-AT Swimmers. These aquatic-terrain armored transports pull up alongside the platform to load and discharge passengers and cargo. The vehicle can also dive beneath the surface to enter one of the underwater launch ports. See episode five for more information.

Energy Fence. Towers stationed around the perimeter of the base project a deadly energy field beneath the water, forming a fence of energy from the surface down to the sea bed. Sections can be turned off to permit access to the garrison.

Tractor Beam Anchors. The garrison is ringed by tractor beam projectors that anchor the base to the sea floor. This prevents drift and stabilizes the entire structure.

Event #1: Getting Into the Garrison

Because the PCs have Pek with them, getting into the base is easy, since he has already scouted the underwater entrances and has been inside the structure. Start the action with this read aloud:

Pek leads you to a spot near the garrison. He settles down to watch, motioning for you to be quiet. He seems to be intently studying something, and then you notice the slight rippling effect in the water ahead of you. A school of fish swim around the ripple, but a few wander too close. The zap is audible as the fish encounter the nearly invisible energy fence. More time passes, then the ripple fades. Pek motions again, leading you forward through the now-open area.

To conserve power the fence is set to stunning force, mainly to keep out fish and test the machinery. Touching the fence results in a 4D energy charge that causes stun damage and repels whatever comes in contact with it.

Sections of the fence are turned off periodically as the technicians test the machinery. It is at these times that the way inside is safest. If the PCs insist on proceeding with any powered vehicles (other than their powered gear) the Imperial sensors pick them up and the base goes on alert.

Event #2: Inside the Fence

Once inside the fence, they must pass probe-Droids and proximity mines to reach the base proper. Again, Pek has already figured out a safe path, and he will point out the types of defenses as they pass. Even so, the PCs must make two Moderate *search* rolls to avoid the Droids and the mines.

If they fail the probe-Droid roll they have one round to disable the Droid before it gives the intruder alarm (and puts the base on alert). The Droid takes a full combat dodge to avoid attacks. A wound result or greater knocks the Droid out of commission.

Probe Droid: STR 4D, blaster 4D, search 4D, dodge 2D+2. Weapons: blaster cannon, damage 4D+2.

If a PC fails to notice a proximity mine, it explodes causing 5D damage to that PC, and 4D stun damage to all others. The mines are not yet fully functional and go off all the time, so this does not put the base on alert. However, two sea-troopers make a half-hearted investigation of the area if the Rebels linger too long.

Once the PCs have made it past the outer defenses, Pek leads them through an unfinished launch port. There are three of these, one of which is operational.

Inside the Garrison

Only a few areas inside the garrison have been described. Everything else is still in various states of construction. Only the marked events must occur, and these have been designed to drop in anywhere in the garrison. The base is too big and there aren't enough personnel to adequately cover every possible area the PCs may visit. To build the mood here, allow vast stretches of the garrison to be spooky and deserted. But feel free to throw Imperials or an event at the PCs whenever you feel a need for action.

Garrison Sub-Level

The sub-level of the garrison houses the main power and back-up generators, the tractor beam and deflector shield stations, three observation decks, the environmental control station, waste disposal units, and storage facilities. There are also the launch ports for all submersible vehicles, and the water shaft leading up to the first level.

Launch Ports. The working launch port observation deck holds five technical staff, two storm-troopers, and two security personnel. The deck, located above the port, has transparisteel walls that look out upon the ocean and into the launch ports' connecting pool. The floor is also made of the clear material so that the deck officers can

view craft on the approach, as it travels through the port, and once it reaches the connecting pool. Light from the deck illuminates the port, and guiding lights lead into the launch area.

The connecting pool mounts three laser cannons, one aimed down each launch port. These blasters are all in working order and can be controlled from the operating observation deck. The connecting pool feeds up into the vehicle bay on level one.

Each observation deck is filled with controls, monitors, catwalks, and repulsorlift work stations. All sensors, scanners, visual detection devices, and communication networks operating below sea level feed into these immense chambers.

The non-working ports are empty and in semi-darkness. These non-finished areas are full of exposed wires, open panels, and partially assembled equipment. Nothing works in these areas yet. If the base is on alert, all launch ports are patrolled by an additional three seatroopers.

Imperial Technicians: DEX 2D+1; KNO 2D+2, technology 4D+2; PER 2D+2. All other attributes and skills 2D. Blaster damage: 3D+1.

Stormtroopers*: DEX 1D, blaster 3D, brawling parry 3D, dodge 3D; STR 2D (3D for damage purposes), brawling 3D. All other attributes and skills 2D. Blaster damage: 4D.

*These codes reflect armor adjustments.

Security Troopers: DEX 2D+1, blaster 3D, dodge 3D+2, gunnery 3D. All other attributes and skills 2D. Blaster damage: 3D+2.

Laser Cannon: Fire control 2D; damage 3D against vehicles; body strength 3D (heavy damage to disable). When fired at characters increase the damage code by 4D, decrease character STR codes by 2D, increase character dodge codes by 3D.

Event #3: The Connecting Pool

Pek leads the PCs through an unmanned launch port without alerting the base, but the connecting pool is another matter. The occupied observation deck looks out over the pool, providing a perfect line of sight for the deck crew and their automatic laser cannon. Each PC must make a Moderate *sneak* roll to get past the observation viewport undetected. From there they will have to swim up into the vehicle bay on level one.

Also, if they make an Easy *Perception* roll, the PCs realize that the top of the unfinished launch port hasn't been completed yet. Water fills the empty area that will eventually become another observation deck. The PCs can swim through the chamber to a glowing doorway. A repulsor field covers the open portal, holding the water back (employing technology used in deep-space hangar bays) so that it doesn't spill into the sub-level hallway. PCs can step through the field, but the water remains on its side of the energy wall. Once inside, allow the PCs to wander where they will until you decide to spring the next event.

Main Generators. The access doors to this area are sealed. It takes a Difficult *security* roll to bypass the locks. This huge, machine-filled chamber contains six technicians. They currently test the equipment to make sure that everything works properly. They flee at the first sign of violence. PCs who manage to get in here must make Difficult *technology* and *demolition* rolls to sabotage the generators enough to cause their permanent failure. This puts the base on alert immediately and activates the weaker backup systems.

Environmental Control Station. The doors to the environmental control station are sealed. Huge fans circulate air throughout the base from this large chamber. Purifiers and temperature/humidity/oxygen sensors kick in and out constantly,

Imperial Aquatic Garrison Personnel & Vehicles

These numbers reflect the understaffed garrison company at this point in the adventure.

Personnel

Stormtroopers	50
Seatroopers	30
TIE Fighter Pilots	14
Repulsorlift Technicians	5
Sensor Technicians	2
Gunners/Weapon Technicians	10
Imperial Intelligence	1
Base Security	20
Perimeter Support	10
Command Personnel	5
Diplomatic Personnel	2
Support/Services Personnel	25
Technical Personnel	15
Science Personnel	8
Medical Personnel	10

Total 207

Vehicles

Waveskimmers	15
Wavespeeders	3
AT-AT Swimmer	1
TIE Fighters	10
TIE Fighter Boats	2
Cargo Shuttle	1
Miscellaneous Vehicles	6

Total 38

adjusting the environment quality each time. If the PCs wish, they can enter the air ducts (easily big enough for even a Wookiee, or Pek) in the guise of a repair-crew, if the base is not on alert. The air ducts wind throughout the base and can be used to travel from level to level.

Tractor Beam/Deflector Shield Generators. These stations contain the controls and power cells that operate the anchor tractor beams, the base deflector shields, and the repulsorlift beams.

Waste Disposal. This is the garbage and sewage recycling area, and it looks just like the one in the first *Star Wars* film. Although it hasn't had time to grow life-forms, it's still an unsavory place to be. Magnetically sealed doors at opposite sides of the chamber remain closed, while the chute above the chamber has dump ports on every level of the base. The chute can be used to get around the base if it is on alert.

Stormtrooper Patrols. Three patrols of three stormtroopers each wander this level on regular intervals. A roll of 1 on a six-sided die determines that the PCs have run into a patrol. (Roll every time they exit a chamber.) An Easy *hide/sneak* roll must be made by each Rebel to avoid being seen whenever they encounter a patrol.

Because of the confusion inherent in setting up the new base, Easy *command* or *con* rolls allow the PCs guarded access in the guise of technicians, commanders and the like if stormtroopers approach them. If the base is on alert, the PCs will not be able to *con* or *command* the stormtroopers.

Rewarding Fast-Moving Players

Sometimes players have a tendency to mull over every plan for hours, to ask innumerable questions, and to generally take the slow and careful approach. This is an anathema to *Star Wars*, which is at its best when run with fast, high-speed action.

One reason players do this is that in other roleplaying games, GMs are told to take great delight in punishing players if their plans aren't perfect. This encourages players to try to anticipate every little detail.

So one way to speed your players up is to reward them for fast, exciting-sounding ideas — even if they are flawed in execution. Without being ridiculously lenient, allow slightly flawed plans to succeed. This encourages your players to think fast (translate: exciting) rather than carefully, deliberately examining every single possibility.

Garrison Level One

Heavy blast doors open onto the five-level high vehicle bay. Water fills the lower area, forming a continuous passage down into the sub-level connecting pool and launch ports. A dock runs along the circumference of this massive area, and ports and bays are being readied for the many vehicles that will one day fill this base. Now, though, there are only a few craft here.

This is a somewhat busy place. Technicians on one section of the dock examine the eight parked waveskimmers, while three seatroopers drive three others around the bay (the other four waveskimmers are out on patrol). Another group of techs, working the bay repulsorlift projectors, lower a wavespeeder from its level two berth into the water. There is also a TIE fighter rack that appears to descend into the pool from the third level. While it has spaces for 10 TIEs, only two vehicles are stored here. If a PC makes a Moderate *Technical* roll, he or she determines that these particular TIEs have been designed exclusively to operate under water.

Miscellaneous vehicles are also in evidence, such as repulsor cranes, loadlifters, and other construction craft. Somewhere up above on one of the maintenance platforms, many technicians busily work with laser welders and sonic drills. They are putting the finishing touches on the Swimmer, but the PCs can only guess what they might be up to.

The other areas on level one are mostly finished and operating, albeit with a skeleton staff. Make this level a stark contrast to the rest of the facility. The rooms are in such repair that the PCs should feel disturbed and nervous by the lack of people. They should expect to run into crowds of Imperials every time they open a door or round a bend. In fact, on a roll of 1 or 2 on a six-sided die, have them run into somebody (roll every time they exit a chamber).

Garrison Levels Two and Three

Levels one through five of the base are identical in layout and design, specialized chambers built around the open, deck-spanning vehicle bay. However, levels two and three of the garrison are not yet occupied by any personnel. They are dark, damp, and in various states of completion. Use narrative techniques described in *Star Wars: The Roleplaying Game* to give the sense of emptiness and heighten the not-yet-ready feel, but don't let the PCs wander too long in the unoccupied areas.

Event #4: Native Life Form

An amphibious native life form has gotten into the garrison. This encounter can occur in the waste disposal unit, the air ducts, or anywhere on levels two or three.

Battle for the Golden Sun Adventure Script

Start the Script

1st Rebel: There I was, minding my own business on guard duty, when this ship comes to a screeching halt in front of Delta Base. And guess who stumbles out of it?

2nd Rebel: You told us this story! It was that Mon Calamarian over there, the one clutching the hunk of rock. Reکارا.

GM (as Reکارا): I am Reکارا, listener to sorrow.

3rd Rebel: She still isn't making much sense, poor girl. Goes on lots of missions with the Alliance dignitary named Mors Odrion, then one day their ship is lost. Next thing we know she shows up at Delta Base half crazy and with no idea what happened.

GM (as Reکارا): Odrion? Poor Odrion. On Sedri, strange Sedri. We must rescue him! We must stop the crying!

4th Rebel: She did tell the base commanders something about Golden Sun.

5th Rebel: Isn't that the new weapon mentioned in the Imperial communiques we intercepted?

6th Rebel: You got it. Which means there'll probably be Imperials crawling all over this planet.

GM (as Reکارا): Swimming. Not crawling. Sedri is all oceans — no land at all. The sea cries at night when the water turns gold.

4th Rebel: There she goes again! Are we sure it's safe to have her along?

3rd Rebel: High Command said she'd be very valuable to us, and to give her time. They think she's recovering slowly from whatever drove her nuts in the first place.

2nd Rebel: I just wish I knew what she was talking about.

6th Rebel: I've punched the coordinates we took from Reکارا's ship into our nav computer, but there's got to be something wrong. These readings say we're jumping into the middle of a sun. The hyperdrive inhibitor is going to boot the program any second now. . .

1st Rebel: Somehow I doubt that this is what High Command meant when they said to be on the lookout for "Golden Sun." I really don't think they want us to plunge into one! Say, why didn't the program crash?

GM (as Reکارا): No boot, no crash! I fixed it! See, here is the inhibitor module! No more nasty cut-off functions!

5th Rebel: That's it! This crazy Mon Cal is going to kill us! Can anybody fix the inhibitor before we come out of hyperspace?

2nd Rebel: Too late. We're already slowing back into realspace. According to those readings, we should come out in orbit around one mighty powerful sun.

3rd Rebel: We'll be so close we won't even feel the heat when the hull melts.

1st Rebel: Why'd I have to be the one on duty when her ship came in? Can anyone tell me that. . .?

GM: Before anyone can answer, space shifts and your ship emerges from hyperspace. If the nav computer is right, you are all about to die. . .

THE CITY OF FITSAY

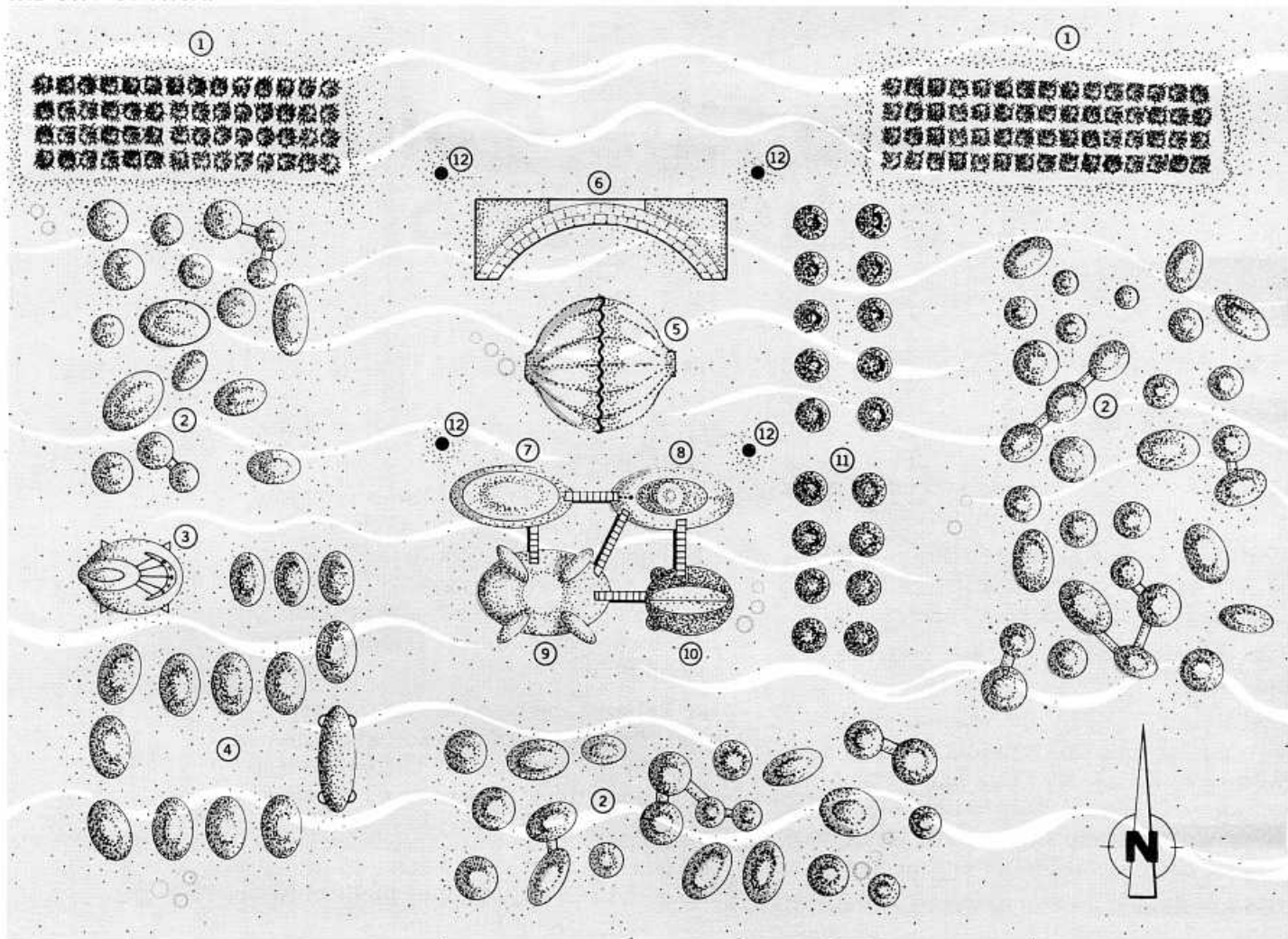

MAP KEYS

THE CITY OF FITSAY

- | | |
|------------------------|---------------------|
| ① Farms | ⑦ Priest House |
| ② Houses | ⑧ High Priest House |
| ③ Inn | ⑨ Audience Hall |
| ④ Marketplace | ⑩ House of War |
| ⑤ The Great Shell Dome | ⑪ Warrior Monk Huts |
| ⑥ Sacred Pews | ⑫ Guard Towers |

THE CORAL CAVES

- | | |
|------------------|-----------------|
| ① Entrance Hall | ⑩ Crossroads |
| ② Divided Hall | ⑪ Hall #1 |
| ③ Huge Chamber | ⑫ Hall #2 |
| ④ Narrow Passage | ⑬ Hall #3 |
| ⑤ Anemone Farm | ⑭ Room #1 |
| ⑥ Seaweed Room | ⑮ Room #2 |
| ⑦ Wide Hall | ⑯ Room #3 |
| ⑧ Small Chamber | ⑰ Great Chamber |
| ⑨ Secret Chamber | |

THE CORAL CAVES

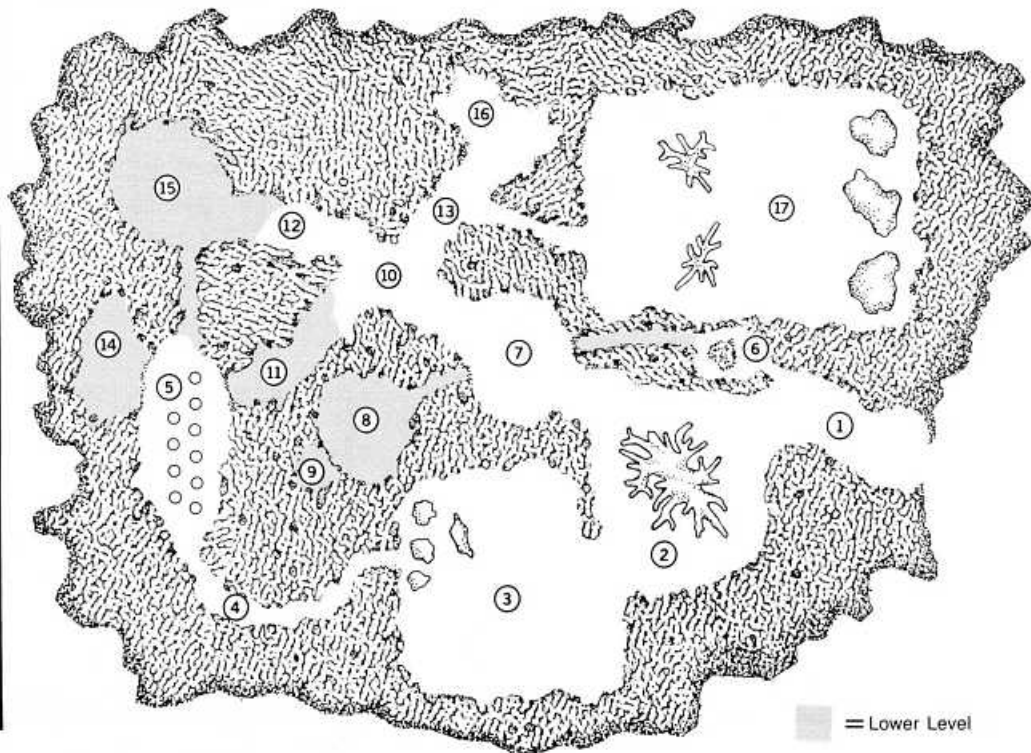

■ = Lower Level

SPACE BOAT EXPLORER

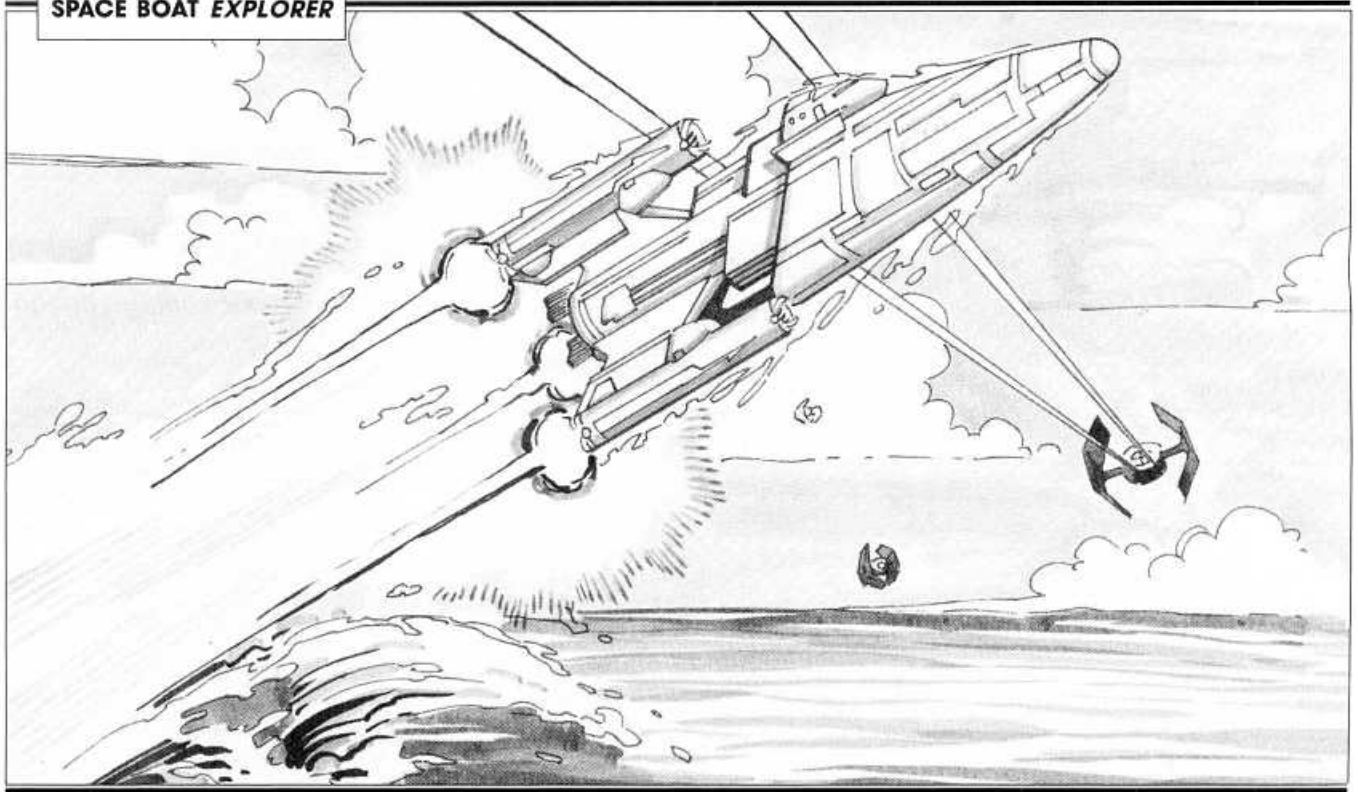

Pek, Sedrian Priest

Template Type: Quixotic Jedi
Ht.: 3m **Sex:** Male

DEX 3D+2	PER 3D
Sun Gun 4D+2	Command 4D
Spear Gun 4D+2	Search 4D+2
Melee 5D	STR 3D
KNO 2D+1	Brawling 4D+2
Sea Survival 4D+1	Swimming 6D
MEC 2D+2	TEC 2D+1
	Medicine 3D+1
	Sense (1D)



Physical Description: Pek is a large, powerfully-built Sedrian. He wears a golden circlet engraved with a coral pattern.

Equipment: Sun gun (5D stun damage), spear (damage 4D+1), seaweed extract (equals two medpac applications).

Background: Pek, the son of High Priest Cardo, is a priest of the Golden Sun and a leader among his people. He has been taught to preserve the customs of his people and to protect the sun caves. Pek has been in the caves and has meditated within the light with his father. He has gained limited Force-like powers through his contact with Golden Sun, but has not yet realized that the coral-dwelling polyps are alive and intelligent. He loved Fala, but Karak's actions have driven them apart.

Personality: Pek is friendly, curious, and somewhat rash. He often swims first and asks questions later. While he follows the pacifistic teachings of his father, he will fight to protect his ideals.

Quote: "I shall take you to the fish-killers floating shell, but first we must see my father."

Commander Aban and Seatroopers



Commander Aban: DEX 2D+2, blaster 3D+2, dodge 3D+2; KNO 3D, alien races 5D, bureaucracy 5D+2; MEC 3D+2, starship gunnery 4D+2; PER 3D+1, command 6D+1; STR 2D+1, brawling 3D+1; TEC 3D, security 4D+1.
Equipment: Blaster pistol (damage 4D), comlink.

Aquatic Stormtroopers (Seatroopers):

DEX 2D, blaster 4D, brawling parry 4D; MEC 3D, waveskimmer operation 3D+2; STR 2D+2, brawling 3D+2, swimming 4D+2. All other attributes and skills 2D.

Equipment: Stormtrooper Aquatic Armor (+3 pips to STR for damage purposes only, does not reduce DEX codes, increases swimming by 2D), built-in comlink, blaster spear gun (blaster damage 5D, spear damage 4D), concussion grenades (damage 5D).

Background: Aban is in command of the Imperial Aquatic Base on Sedri, with express orders to commandeer the mysterious substance called Golden Sun. His base is understaffed and inadequately supplied, but he does have a subjugation team made up of stormtroopers and the special seatroopers. Aban is cold, ruthless, and capable, but he has been placed in a very difficult situation. He works with Karak until his own power base is secure. The seatroopers are deadly stormtroopers trained and equipped to operate in watery environments. Their armor is light-weight and fully loaded with sensors, propulsion units, and breathing gear.

SPACE BOAT EXPLORER INFORMATION HANDOUT

Craft: *Explorer*
Type: Modified Multi-environment Space Boat
Crew: 6
Passengers: 6
Cargo Capacity: 150 metric tons
Consumables: 4 months
Hyperdrive Multiplier: [$\times\frac{1}{2}$]
Nav Computer: [Yes]
Hyperdrive Backup: [No]
Sublight Speed: [2D]
Maneuverability: [1D+1]
Hull: [4D+1]
Weapons:
Two Double Laser Cannons (fire separately)
Fire Control: [2D]
Damage: [4D]
Shields:
Rating: [2D]

Description: The Rebel craft *Explorer* is a modified multi-environment vehicle that can operate in space using hyperdrive or sublight engines, and in planetary atmospheres or liquid environments using repulsorlift engines. Hastily supplied and refitted for this underwater mission, *Explorer* carries a low-power tractor beam projector for anchoring its position at sea. The ship has a full set of passive and active sensors, including radar, sonar, visual scanning, and energy-wave detectors for use in space and under sea.

Crew Positions: Pilot, Co-pilot, Shields Operator, Two Gunners, Sensor Array Operator.

Stored Equipment: Two speeder-rafts (repulsor-driven water surface vehicles that operate like landspeeders and hold four persons each), six glider-sails (for wind sailing or parachuting), six underwater breathing suits with unlimited power cells, six blaster pistols, two blaster rifles, six grenades, six medpacs, two spear guns, and four coils of syntherope.

Karak, Renegade Leader

Template Type: Sedrian Bishop of War
Ht.: 3.4m **Sex:** Male

DEX 3D+1	PER 2D
Spear Gun 5D+2	Command 6D
Sun Gun 4D+1	Con 5D
Melee Weapons 4D+2	STR 4D+2
KNO 2D+2	Swimming 6D+2
Cultures 4D+2	TEC 1D
MEC 2D+1	Control (1D)
	Sense (1D)



Physical Description: Karak is the largest, most powerful Sedrian the Rebels meet. He wears a blue armband with a broken shell pattern engraved on it.

Equipment: Spear gun (damage 3D+2), sun gun (5D stun damage), melee spear (damage 6D).

Background: Once Fitsay's bishop of war, Karak now leads the Sedrian renegades. He preaches that the Golden Sun should be open and accessible to all, but actually wants the power for himself. He travels with six followers and a razort, calling for all Sedrians to reject the sun priests and their teaching.

Karak's Force Powers: Once Karak reaches the sun caves (episode six), he temporarily gains the following powers. Control 9D, Sense 9D, Alter 6D. Karak can fire sun beams directly from coral crystals which he clenches in his fist (damage 5D), block blaster bolts (four per round), dissipate blaster energy (four per round), control pain (ignores wounds), accelerate healing (two levels per round), and inflict pain (stun damage) due to the power he steals from the Golden Sun.

Quote: "The Golden Sun must be for all Sedrians! We must break the shell that imprisons it and set it free!"

Rekara

Template Type: Mon Calamari
Ht.: 1.6m **Sex:** Female

DEX 3D+1	PER 2D+1
Dodge 4D+1	Bargain 3D+1
KNO 3D+1	STR 3D
Cultures 5D+1	Stamina 4D
Languages 5D+1	Swimming 5D
MEC 2D+1	TEC 3D+2
Astrogration 4D+1	Computer
	Prog./Repair 4D



Physical Description: Rekara is a bipedal amphiboid from Mon Calamari. She wears a light-blue jumpsuit and carries a chunk of rocky coral.

Equipment: Comlink, chunk of rocky coral.

Background: Rekara has been the constant companion of Mors Odrion, serving within the Alliance diplomatic corps. Her job has taken her and Odrion from system to system in search of supplies and converts to the Rebel Alliance. On a recent mission, they uncovered stories about a newly-discovered world called Sedri. This place was suddenly of interest to the Empire and was rumored to hold the weapon known as the Golden Sun. Rekara and Mors Odrion traveled to Sedri, but were captured by Karak. Rekara escaped, taking with her a piece of Golden Sun. But when the coral was removed from the planet it fell into a death-like state — driving Rekara insane.

Personality: Once bright and adventurous, Rekara is now crazed with grief, driven mad by the dying screams of the coral she carries. She rambles on about Golden Sun, seal people, and terrible cries that only she can hear, but does lapse into moments of sanity to provide a hint or two when necessary.

Quote: "We must find Mors Odrion before the sea screams again and the Golden Sun rises!"

The creature, a twenchok, closely resembles terrestrial octopi, but it has four eyes spaced across the top of its head and can scuttle across dry land using four of its tentacles. Its body and tentacles are normally deep black, but it has camouflage abilities that allow it to sneak up on prey. The twenchok also has a quill-shooting defense mechanism. When the PCs come upon it, it attacks with quills and tentacles for one round, then grapples with the nearest Rebel. If successfully attacked, it attempts to flee for the nearest air vent, while firing quills as it retreats.

Twenchok: DEX 3D; PER 1D; STR 5D; speed code 2D. Quill damage 2D+2 (can fire six per combat round, or one combined volley for 5D damage).

Garrison Levels Four and Five

Armory: The armory on level four holds additional armor for normal base troopers, as well as all weapons and ammunition packs.

Training and Recreation: The level five training and recreation center is fully functional. This room is full of high-tech exercise equipment, including powered weights and null-grav trampolines (one on the floor and one on the ceiling).



Finding Things Out

The PCs may or may not attempt to question or interrogate various base personnel, or to use base computer terminals. As usual, storm- and seatroopers reveal nothing. The base computer, security personnel, technicians, and officers have various degrees of knowledge that they may reluctantly give out. Some methods of obtaining information include interrogation (Moderate *command* roll), Force powers, trickery (Easy or Moderate *con*) and, where appropriate, Difficult *computer programming*. Use the following as guidelines to answer any questions the PCs ask.

Mors Odrion. No one in the base knows anything about the Alliance dignitary. The officers confirm that he is not on the base at all.

The Sedrians. Most of the techs and security personnel deny any knowledge of the Sedrians. One of them might admit that he has seen a seal-man at the base, talking with Aban.

New Arrivals. The next shipment arrives momentarily and includes the servomotor for the AT-AT Swimmer, as well as two squads of seatroopers.

Plans. Plans to attack the Sedrian villages to find the source of Golden Sun are in the computer. If Pek hears this, he leaves the base immediately to warn his father.

Access. Various areas of the base are restricted, requiring computer codes or passwords for access. Security personnel can be tricked or forced into revealing the access codes for the upper levels. These can also be accessed by making appropriate *security* rolls.

Map. Any computer terminal can output a holo of the base plans. Simply show the players the entire base map if they make a Moderate *security* roll and an Easy *computer programming* roll.

Trooper and Security Barracks. Normally the stormtrooper barracks would only be on levels one through three, with security barracks on levels four and five. However, the troopers are temporarily using level four until the lower level barracks are completed. The security barracks occupy level five.

Base Security. This is where on-duty security personnel wait for assignments, check in, and monitor the rest of the base. At present it is

constantly occupied by four security men armed with heavy blasters. Two monitor screens are active, (three others are in various states of completion).

Detention Block. This is the most logical place for the PCs to head once they get inside the base. It can be reached through the security area, or through various ducts and chutes.

There are currently no prisoners of any kind in the garrison. Therefore, the detention block on every level is completely empty. This area is particularly eerie (you might want to throw a little scare into your players here with some creaking or shadows — perhaps calling for an Easy *street-wise* roll to avoid firing off a blaster because of nerves). A thorough search reveals that Mors Odrion isn't here, and an Easy *bureaucracy* roll indicates that no prisoners have ever been here and none are expected in the near future.

T he Base on Alert

If the Rebels do something that alerts the base to their presence, this episode suddenly turns grim. Troopers actively patrol to find them (a roll of 1-3 on a six-sided die for every encounter check) and all patrols consist of six stormtroopers.

Medical Bay. On level three, the large medical bay contains the most modern equipment. While not fully functional, enough has been completed to handle the current complement of garrison staff. Three medpacs can be found on a Moderate *search* roll. If any PC is incapacitated or worse, they can use the bacta tank on a Moderate *medicine* roll.

Science Labs. Levels four and five hold the scientific research labs. Level five is empty, level four currently contains a marine biologist and an astrophysicist, who are working to solve the mystery of Sedri's unusual gravity waves. If they are properly questioned, they feed the PCs bits of theory about a substance that interferes with the local gravity field, as described in the introduction.

Droid Shops. There are a small number of Droids on duty within the garrison. Only the probots that patrol the perimeter pay any attention to the PCs. In the Droid shop, several Droids await repairs. A Difficult *Droid repair* roll allows the PCs to obtain information from the grateful Droids. The Droids will not leave the shop.

Garrison Level Six and Above

Passage to level six is restricted to authorized personnel. If the access codes have not been obtained, it requires a Moderate *security* roll to make the turbolift rise that far. If the base is on alert, the turbolift cannot be used to get above level five.

Computer Room. The computer compiles sensor data and monitors all personnel and roster changes. Easy *computer programming* rolls can glean the following information (one roll each):

- There are no prisoners in any cell block.
- The Swimmer is ready and awaiting the servomotor that should arrive on the upcoming supply wave, within the next two hours.
- A Sedrian calling himself Karak is currently negotiating with Commander Aban in the diplomatic offices.
- The base is scheduled for completion in five months.

Meeting Rooms. This area, broken into numerous cubicles of various sizes, is used for staff conferences. Each cubicle contains a working, portable holorecorder/projector. The turbolift car rises from a hole in the center of the area through a clear transparisteel cylinder.

Offices. These are dark and empty — no one has arrived to use them yet. A working computer interface is in one wall; it can be used to create authentic-looking data tapes to show to guards and security personnel, or to gather information (see "Computer Room" above) from the base computer with Moderate difficulty rolls.

Base Control Room. Computer stations monitor the life support levels, perimeter defense reports, power supplies, security requests, etc. The room resembles a dispatch office in a large city police department, or an air-traffic controller's tower. Five personnel and two stormtroopers are on duty here at all times.

Reception Area. Several comfortable chairs and a plain, unoccupied desk fill the room. One security person is here, nodding off to sleep in one of the chairs.

The Higher Levels

If the PCs continue higher, they come to levels seven and eight. Level seven is the TIE fighter hangar deck. Not yet complete, it nevertheless holds 10 TIE fighters on the ceiling racks.

The flight control center is at the center of the hangar, and lies just below the sensor suite tower

(there is an access portal in the ceiling of the control center). Three flight personnel are on duty here, preparing to bring in the supply ship. Four stormtroopers and a security man complete the detail. Once the supply shuttle lands on the outside docking platform, the PCs will have access to a ship if they need one.

Level eight is the TIE ejector flight deck. It is silent and empty.

Event #5: Looking In On Aban

If the PCs use a monitor camera or actually sneak to level six, they see Commander Aban in conference with the Sedrian Karak (see the pullout for more about Karak). Karak is huge and vicious-looking, and wears a dark blue arm band engraved with the broken shell symbol of the renegades. Pek recognizes and names the one-time bishop of war immediately. The PCs see:

Karak smiles evilly, showing rows of sharp-pointed teeth. "So, are my terms acceptable Commander Aban?" Aban smiles back, but cannot match the Sedrian's look. "They are," he says. "The attack begins in three days." Karak spreads his webbed hands wide and claps them together as he says, "Very well. I pledge my aid upon the breaking of the Great Shell!"

The above scene can be recorded if anyone has a holorecorder.

If the PCs attempt any action against Aban or Karak now, go to Event #6. When the supply shuttle arrives, the commander is immediately surrounded by more troopers than they can realistically handle.

Event #6: The Supply Shuttle Arrives

Once you feel the PCs have wandered about enough and you wish to bring this episode to a close, read the following section aloud. Give the PCs plenty of time to collect items and information. As long as they seem to be accomplishing something and having fun, let them keep going. But when the action begins to fade, read the following section:

Warning claxons sound, and a voice echoes from hidden microphones. "The supply shuttle has arrived. All technical and security personnel please report to the vehicle bay for AT-AT activation." Without warning, people appear all over the place, running in all directions. They don't seem to notice you, but that probably won't last forever. They rush through large blast doors that open onto an

observation gallery atop the massive vehicle bay. On a floating berth, suspended in all its glory, is a modified AT-AT — a Swimmer! A terrible, beast-like head; a powerful, turtle-like shell of blaster-resistant armor; deadly blaster cannons that gleam evilly in the artificial lighting — this monster vehicle of war is as impressive and dangerous-looking as its land-bound counterpart. With a rumble, the repulsorlift projectors lower the craft down into the sea-level pool. Then the Swimmer switches on its own engines and dives out of sight.

The shuttle containing the swimmer's servomotor replacement has arrived, and the base is thrown into a state of organized confusion as the staff works to off-load the supplies. Of course, the first thing taken care of is the Swimmer, which puts the staff into an excited mood. It is quite easy, amid the confusion, for the PCs to descend to the launch ports and swim away. Trying to get to any restricted areas, or get near the control rooms or vehicle bay, is quite impossible, because the shuttle has brought a large contingent of fresh troops who immediately take up security positions throughout the base.

Getting Away

If the PCs are moving on their own, allow them a leisurely return to the launch ports. If you feel the need for some thrills, or they're being chased by stormtroopers who discovered them, you can have an exciting running battle starting with where the PCs are and ending at the launch ports.

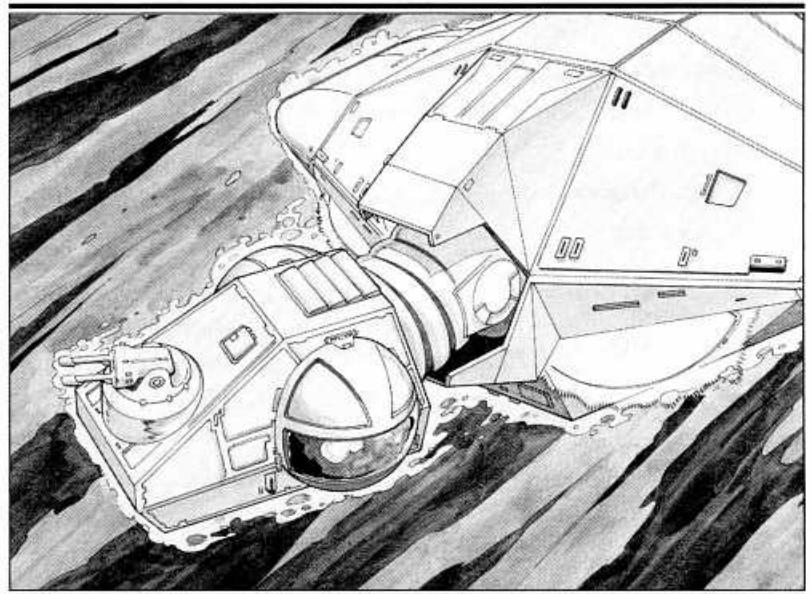

No more than six stormtroopers confront them at one time — just use the stormtroopers to guide them toward the exit. You may also want to have some neat leaps and swings across not-yet-completed sections of the garrison, adding to the thrill of the moment.

The turbolift stops working on level two if there is a chase going on, and the PCs have to get away before more squads of stormtroopers start showing up. The best ways for a fast exit are through the air ducts and garbage chutes. If the PCs haven't been using these up until now, an *Easy Perception* or *Knowledge* roll lets them think of it. Pek can't maneuver or climb in the garbage chutes, but if someone makes a Difficult *lifting* roll, Pek can be heaved through a chute.

If all else fails, the PCs might get out the airlock on level three, or run to an open port and dive out into the ocean. Give this scene an appropriately breakneck pace tempered with an occasional blaster bolt crashing into a nearby wall, and you can't go far wrong allowing any half-reasonable method of escape.

After the Rebels escape the base, regardless of how long they were there, Pek takes them to Fitsay to warn his father of Karak's treachery.

G uidelines for Combined Actions

In general, use common sense when determining whether an action can be combined. Most actions *can* be combined. Things that *cannot* be combined include all reaction skills, movement rolls vs. terrain, beast riding, operation of a single vehicle with vehicle skill (copilots don't combine, they just perform other actions), most Perception skills (except con and search), climbing/jumping (sometimes), stamina, swimming (sometimes), and Force skills.

To figure out *how many* people can combine to do a single action, use the skill of the lead character minus one. For example, if they are searching and the lead character has 4D, no more than three additional people may combine. In the case of combat, use the *command* skill to determine the maximum number of combined fires rather than the blaster skill itself. Note that stormtroopers are *not* under this restriction — this is one of their advantages.

IMPERIAL AQUATIC GARRISON MAP KEY

Exterior

- ① Sensor Suite Tower
- ② Heavy Twin Turbolaser Turrets
- ③ Heavy Laser Turrets
- ④ TIE Fighter Launch Chutes
- ⑤ Heavy Blast Doors
- ⑥ Guard Towers
- ⑦ Shuttle Landing Platform
- ⑧ AT-AT Swimmer Dock
- ⑨ Connecting Ramp
- ⑩ Flotation Collar
- ⑪ Undersea Launch Ports
- ⑫ Tractor Beam Anchors

Interior

- ⑬ Connecting Pool
- ⑭ Observation Decks
- ⑮ Main Generators
- ⑯ Environmental Control Station

- ⑰ Deflector Station
- ⑱ Tractor Anchor Control
- ⑲ Storage
- ⑳ Waste Disposal
- ㉑ Backup Generators
- ㉒ Level 1-2: Storage Gallery
Level 3-4: Armory
Level 5: Training and Recreation
- ㉓ Level 1-3: Stormtrooper Barracks
Level 4-5: Security Barracks
- ㉔ Level 1-5: Base Security
- ㉕ Turbolifts
- ㉖ Level 1-5: Detention Block
- ㉗ Level 1-5: Technical and Service
Personnel Barracks
- ㉘ Level 1-2: Technical Shops
Level 3: Medical Bay
Level 4-5: Science Labs

- ㉙ Level 1-2: Storage Gallery
Level 3-5: Droid Shops
- ㉚ Level 1-5: Vehicle Bay
- ㉛ Level 1-5: Vehicle Maintenance
- ㉜ Sensor Monitors, Tractor Beam and
Shield Controls
- ㉝ Computer Room
- ㉞ Meeting Rooms
- ㉟ Officers' and Pilots' Quarters
- ㊱ Trade Mission, Diplomatic Offices
- ㊲ Base Commander's Offices and Quarters
- ㊳ Officer Rec Room
- ㊴ Offices
- ㊵ Base Control Room
- ㊶ Reception Area
- ㊷ TIE Fighter Ceiling Racks
- ㊸ Lift Platforms (to level 8)
- ㊹ Flight Control Center

E pisode Four Renegade Raid

Summary

In this episode, the PCs meet Karak's renegades as they defend Fitsay and the Great Shell Dome from a raid by Karak's followers. After finding out from a captured raider that the renegades hold Mors Odrion, the PCs go to Karak's settlement to fight or bargain for his return. There's only one hitch — Odrion isn't there.

However, the PCs do meet Fala, Karak's daughter, and have a chance to persuade her of the error of her ways. Her attraction to Pek doesn't hurt matters any. If the PCs are successful, they determine that Karak himself (along with his faithful bodyguard and his razor pet) has Odrion, and is even now working out a plan that will gain him the ultimate power he so desperately craves.

Return to Fitsay

The PCs return to Fitsay from the Imperial base after a quick, cinematic fade-out/fade-in. (If the PCs went to the Imperial base first and have not yet been to Fitsay, go run Episode Two now, then return here when you're done.) As they arrive (or after Cardo finishes speaking with the PCs, if you're coming from Episode Two) the renegade attack begins. Twelve renegades participate in the raid. If your group consists of four or fewer PCs, only eight renegades attack.

The raiders seek to steal a bit of Golden Sun, to replace the piece Rekara took with her (which happens to have been stolen from the Fitsay in the first place). The renegades plan to divert the priests and open the dome just long enough to take a small piece of Golden Sun, then flee into the deeps.

Stage One: The raiding band approaches from the mountains, using the rocky peaks for cover. They carry sacks of stinger fish, spears, spear guns, and sun guns (which they use sparingly since they do not have many replacement crystals). This stage occurs before the PCs arrive (or before they finish speaking with Cardo).

Stage Two: One female renegade approaches the guard post at the base of the mountain, and pretends to be injured. When the Fitsay guards come to her aid, the others dart from the rocks and overwhelm them. At this point, the PCs might notice some commotion by the cliff base as they return to the city. Let everyone make a Moderate *Perception* check. (If they are with Cardo, they remain unaware of what's happening during this stage.)

Stage Three: The renegades sneak into the marketplace and release the stinger fish. These jellyfish-like creatures savagely attack all moving objects, latching on with their stinging suction cups. They aren't life-threatening, but they are annoying. A school of stinger fish in a crowded area causes confusion and near-riotous behavior. The warrior monks immediately respond to restore order, leaving their various posts to quell the uproar.

A tower guard sounds his horn, alerting the priests to the situation. If the PCs are returning to the city, they arrive near the north-west farms when the horn sounds. If they are with Cardo, they hear the horn from inside the audience hall. While they decide what to do, the renegades move into position to attack the tower guards. They use their spear guns to kill the guards, then they swim directly toward the Great Shell Dome. Anyone who touches a stinger fish sustains 6D of stun damage.

Stage Four: The PCs get involved either by assisting in the marketplace or by going to the aid of the tower guards. When they arrive at the nearest tower, however, they are too late. The guards are dead, spears jutting from their pierced bodies. Have all Force-using PCs make an Easy *Sense* or *Perception* roll. If they make the roll, the presence they felt in the Force returns. This time it is afraid. Waves of fear spread over the Force users, whether they made the difficulty roll or not.

Then the sea turns gold as the renegades open the shell dome.

Stage Five: Two-thirds of the renegades secure the opening in the shell and prepare for a siege. The final third break off a small piece of the coral within the dome and race north to escape. When the renegades approach the coral, the Force users feel the waves of fear intensify. Then a scream of pain that only those sensitive to the Force can hear echoes through their souls. Re kara, especially sensitive to this sense, screams along with the hurting coral. See "The Sun Caves" for more information on the coral caves beneath the shell dome.

At this point the PCs should arrive on the scene, along with Pek and four priests. The renegades guarding the dome have never seen aliens, so they won't know what to make of the PCs at first. In that round only, the PCs get one free haste to all their actions. After that, the renegades fight normally, concentrating on the PCs with their spear guns and energy weapons. Their primary goal is to delay these strange warriors long enough for the other renegades to escape. Re kara will try to convince the PCs to "save the separated ones," urging them to chase after the fleeing renegades. If they decide to swim after the escapees, they must move out before the fourth round of combat or they won't catch them. If they decide to use one of their vehicles, they can wait until the eighth round of combat before they lose the trail.

If the renegade's plan unfolds as outlined above, those left behind will fight long enough to assure the escape of their fellows. After eight rounds of combat they surrender. One of these can be used to provide information in "The Next Step." If the plan doesn't progress that far due to PC intervention, make sure that at least one renegade is heavily stunned or incapacitated so he can be used to provide the information.

Chasing the Renegades

If the PCs go after the escaping renegades within four combat rounds of reaching the shell dome (or within eight if they use a vehicle), they catch up with them. One third of the original renegade raiding party is fleeing north toward Karak's settlement, carrying a piece of Golden Sun with them. Once they catch up, the renegades turn to fight while one of their number continues to swim on, clutching tightly to the glowing clump of coral. Unless at least one PC immediately follows the lone renegade, Karak's follower disappears into the murky water. If caught, the renegade crushes the coral in his powerful webbed fingers, extinguishing its light and life.

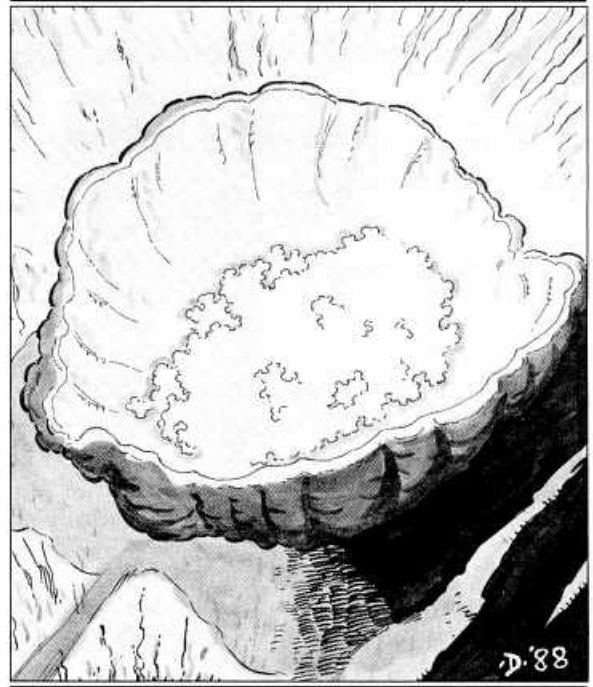

If the PCs wait too long to take up the chase, the renegades escape with the bit of Golden Sun. They return to Karak's settlement with their prize.

The Sun Caves

When the battle with the renegades is over (whether the escaping ones are captured or not), Cardo is so impressed by the PCs performance that he agrees to show them the Sun Caves, to heal their wounds, and atone for their pain. If, by chance, the PCs lose the battle, Cardo feels it is only right to explain to them what it was all about, in addition to providing healing. Either way, he leads them to the dome. Read:

The high priest thanks you for aiding Fitsay in its time of need. "What I am about to show you is the greatest gift that was ever bestowed upon an unworthy people. I ask only that you show proper respect to this power we have been given." With that, Cardo manipulates a hidden mechanism near the slight crack in the dome. Even the small amount of light that spills from this slight opening is blinding. A low grinding hum fills the water. The bright golden crack widens as even more incredibly bright golden beams shoot out into the sea. The once-green waters, already a pale yellow, now gleam bright gold, dazzling your eye and filling you with a sense of excitement and power. The golden glow surrounds you, binds you; you feel your wounds and fatigue disappear.

Any wounds the PCs suffered heal in the basking light of the Golden Sun. As the dome walls open further, they recede into the ocean bottom, and the dazzling coral caves appear to full view. The ocean for as far as the eye can see has turned gold.

What is Golden Sun?

Golden Sun is a living, intelligent organism made up of thousands of tiny polyps. These polyps live within a coral reef and have a communal consciousness. Once the shell dome is opened, the reef can be seen. The reef has hollows and passages that form a network of chambers which the Sedrians call the coral, or sun, caves.

The coral dwellers have an affinity for the Force, although they do not know it by that name. Their lives in the glow of the Force, as well as the power generated by thousands of interconnected minds, produce the powerful effects of the Golden Sun. Unfortunately, Cardo and the Sedrians do not see the coral as a living, intelligent entity. They see it as something great and powerful, but as a tool, not as an equal life form.

Because of this, the coral is sad and melancholy. It wants to share its joy with the entire planet all the time — not just when the dome is opened. While few Sedrians are strong in the Force, none are as strong as any of the Force-using PCs. The Golden Sun, ecstatic that some other life form can hear it, tries whenever it can to contact the PCs through the Force. Of those Sedrians who are strong in the Force, Karak and Cardo are the most powerful. But Karak has seen the power and follows a pseudo-Dark Side, and Cardo has refused to go any further with his own studies and is content to be able to communicate with the coral in a limited way. Their children, however, hold great promise that may come into play before the end of the adventure.

More About Golden Sun

Cardo has no knowledge of Golden Sun's use in foiling hyperdrives. He does know that at times it seems alive, and he has had dreams in which the coral speaks to him, although he can never remember what it says. The sun guns operate using the power of the energized crystals that can be found in the coral caves. But only priests and monks can get the crystals to loose their energy. The crystals are also used to power other work-saving items, but can never be used to kill.

Sometimes a gravely ill Sedrian, when placed in the caves overnight, will be healed. The more often this power is used, the less effective it gets. Cardo suspects that the coral also has other properties relating to far-seeing visions and spatial travel, but will not give any more details at this time.

The Golden Sun coral has an affinity to the Force. The life that flows through and binds the coral calls upon the Force that binds the universe together in joyous harmony, and many of the coral's powers are reminiscent of Force abilities. Those who crave power and the Dark Side will seek the coral for themselves, and those whose hearts are filled with evil will hate the goodness that the Golden Sun projects.

Force users who attempt communication or analysis of the caves do detect life — actually, lots of life. Thousands of voices connected in maddening, joyous song. If they made any of the earlier rolls that let them feel a presence in the Force, they realize that this is the source of that presence. However, they cannot actually communicate until they enter the caves, which Cardo will not let them do at this time.

When as much of this information as the PCs desire is revealed to them, one of the monks approaches to tell Cardo that the renegade prisoner has awakened. Go to "The Renegade Prisoner" below.

The Renegade Prisoner

When the PCs and Cardo question the renegade, he reluctantly reveals the following information. Read:

The renegade holds himself proudly. He still wears the blue armband with the broken sea shell pattern engraved upon it. He speaks clearly and loud enough for all to hear. "Not only have you locked away Golden Sun from our people, high priest, you have taken to dealing with thieving aliens!" He snorts in the direction of you and Re kara. "We will free Golden Sun and make it available to all our people! That is Karak's dream, that is what we fight for. And those aliens that stand beside you, they are weak and unable to breathe the life-giving waters of our planet. We know, for we have one in our camp, a prisoner who shall pay for his crimes against the people!"

The renegade explains that the alien is being held because he is a thief, as is that false water-breather named Re kara who stole Karak's piece of Golden Sun. He is not aware that Karak has been dealing with the Imperials, and will be aghast if such a thing is suggested. He renounces Karak if given proof of such a deed (like being shown a holotape), then becomes depressed because no one of truth and goodness leads the people.

At this point, the PCs are most likely ready to launch a raid on Karak's settlement. Cardo states that he will send soldiers, but demands that he be given the opportunity to parley with Karak first. The PCs may remain hidden if they wish (if they suggest sneaking into the settlement during the parley, Cardo reluctantly agrees).

D istances Between Scenes

Most of the time, episodes that take place far apart can be segued by a "you travel for a while, and then you're there," or simply a "fade out . . . fade in." In *Star Wars*, that's the only way to handle transitions.

However, players may want to know how far apart things are, in order to judge how long a trip will take, or where to put a broadcast unit with a range of 1000 km, or whatever. So when running your adventures, make sure you have a good idea of where things are in relation to each other.

In *Battle for the Golden Sun*, the Imperial base is 200 km southeast of Fitsay, and Karak's settlement is 300 km north of Fitsay.

Karak's Settlement

The expedition to find Mors Odrion will be organized quickly (scene change and they're ready). During this transition, read the following section aloud:

While the monks get organized, Cardo takes the renegade prisoner into the sun caves. Pek stays with you. They remain within for only a few minutes. When they came out, the renegade seems dazed and uncertain. Cardo grimly speaks, "Now I know the way to Karak's settlement. Let's go."

Let a Force-using PC make an *Easy Sense* or *Perception* roll. If he succeeds, explain that while the Sedrians are in the caves he feels a sudden and powerful disturbance in the Force. It doesn't last long enough to get details, but it feels as though the Force was just used to accomplish something — and it wasn't necessarily the type of use the Jedi encourage. What happened, although the PCs shouldn't be told this, is that Cardo used the Golden Sun to look into the renegade's memories, much the way Karak did with Mors Odrion.

The trip to the renegade camp can be a quick transition — fade out, fade in. Tell the players that the PCs and the party of Fitsay (10 monks, Cardo, Pek, and the PCs) arrive after travelling for several hours. They can survey the settlement from a distance and decide on a course of action. The settlement is much less permanent than Fitsay, and much smaller. A large tent fills the center of the camp, with a number of smaller tents and tiny huts all around it.

The Opening Parley

Cardo insists upon approaching under the flag of truce. The PCs may accompany him or not, but Cardo will not be swayed and will not grant the PCs any time to perform other actions. If they wish to sneak into the settlement while the parley is going on, that's their business. As soon as things are settled, read the following aloud:

Cardo, Pek and the monks approach the settlement and announce their presence with great bellows. They wait patiently while the renegades mill about in frightened confusion. A squad of armed renegades appears, but keeps its distance.

Then, from the central tent, a great horn blares out. A group of heavily armed renegades emerge from an open flap. Then a beautiful Sedrian woman appears and, accompanied by the renegades, swims toward the Fitsay party.

If the PCs have stayed back or are sneaking around the camp, skip the rest of this section and go to "Sneaking Into the Camp."

Otherwise, when the woman appears the PCs hear Pek hiss "Fala!" The renegade soldiers wait patiently, but some nervously finger their weapons. The approaching Sedrian is Fala, Karak's daughter and now true priestess of the renegades.

Always keep in mind that Fala is *not evil*, just misguided. When Fala and Cardo are ready to parley, read the following aloud:

Fala says, "So. I see that the Fitsay are still as dishonorable as ever, since they obviously deal with fish-killers and thieves." (She points at Rekara.) "I cannot possibly imagine why you have come here, but since my illustrious father Karak is away right now, I will deal with the Fitsay. Why have you come?"

Cardo replies, "These walking ones are not the fish-killers, whom I have less love for than anyone. Nor are they thieves. They are brave and honorable, and I come here with them for two reasons: to secure the return of one of their kind, and to appeal to you to join us in defending against the fish-killers."

The opening rounds are finished. Cardo and Fala bow to one another, and Fala dismisses all but a few of the guards. The PCs and soldiers are asked to set down their weapons.

Talking with Fala

During the rest of the parley (the conversation is much more informal than the stylistic speech used in the opening), Fala listens to cogent arguments, but still has strong opinions of her own. Cardo and Pek do their best to present their

side of things, but it should be up to the PCs to provide the convincing arguments that finally sway Fala.

- According to Fala's father, Karak, the Fitsay are ruled by a greedy powermonger. Fala asks one PC for an honest appraisal of Cardo. She ignores Pek.

- Golden Sun has many powers which Cardo has not shared with the Sedrian people, preferring to keep them for his own personal gain. Her father intends to create a sun cave of his own (the supposed reason for the raid), study Golden Suns assiduously, and reveal his discoveries to all. She asks a different PC what he knows of Golden Sun, and if he believes in equality for all people.

- Imperials are so obviously evil that anyone who has dealings with them is tainted. Her father has told her that he will destroy the fish-killers with the powers of the Golden Sun. She asks another PC how he and his clan are different from the fish-killers.

- She admits that the renegades hold Mors Odrion, but refuses to return him without her father's consent. She also demands that Rekara be turned over to them for punishment, and the Golden Sun piece be returned. She intends to return the two after a suitable time of incarceration.

In addition to well-reasoned or passionate answers to her questions, the PCs have several ways they can disarm Fala and bring her around.

If they have a holo recording of Karak with Commander Aban, Fala will immediately commit her people to helping defend the sun caves. She is shattered by the revelation that her father has betrayed his trust, and will commit 100 renegade soldiers.

If the PCs heard Karak and Aban and describe the scene accurately (including Karak's pledge), she will be uncertain and agree to accompany 40 renegades to Fitsay to defend the sun caves.

If they tell stirring tales of Imperial oppression, but only saw Karak and Aban at a distance, she will be guardedly neutral and will accompany an honor guard of 12 renegades for additional discussion at Fitsay, pending her father's return.

If the PCs ask her to search her feelings and trust to the Force, she will reach out to a Force-using PC with her own limited powers. Have the PC make an *Easy Sense* or *Moderate Perception* roll. The PC experiences a gentle probing as Fala searches not only her feelings, but his as well. The PC also experiences another presence as Pek joins the link. A feeling of happy times, with Pek and Fala swimming side-by-side, is shown to the PC,

Sneaking Into Camp

If the PCs choose not to be a part of the parley, they will probably hang back or approach the village from another angle. If they hang back, Cardo gestures them forward after the opening round of the parley. If they choose to sneak into the settlement, let them check out a few huts and tents. They find no sign of Mors Odrion. As soon as they are satisfied that he is not there (or you feel the adventure tempo is dragging), a group of 24 renegade soldiers surprises the PCs and takes them prisoner. They are brought before Cardo and Fala (who makes a disparaging comment about thieves). Cardo smooths things over by explaining how concerned the PCs are about their missing friend. Proceed to "Talking With Fala."

If the PCs somehow manage to get away and wait for Cardo's report, give them sketchy details about the course of the parley, and have Fala and 12 renegades accompany the Fitsay back to their village.

but he does not know if that is a scene from the past or the future. Fala breaks the link, and her manner softens. She agrees to let the Rebels visit with their prisoner.

You'll have to wing it if they come up with other arguments. Just keep in mind that:

- Physical force does not impress Fala. The renegades might be overwhelmed by superior firepower, but they will not be cowed. If the PCs fight, almost a hundred renegade soldiers arrive to repel them.
- If the PCs really convince Fala overwhelmingly to join with them, she will commit 100 soldiers to attack the Imperials. If they convince her that they have right on their side, she will commit 40 soldiers to defend the sun caves, and if they give her doubts of her position, she will accompany 12 soldiers to Fitsay for further parley.

Seeing Mors Odrion

If the PCs convince Fala to let them see Mors Odrion, they will be accompanied by many nervous guards to a sturdy hut. The guards open the door at her command... but there is no Alliance dignitary within! Fala is shaken by this and demands an explanation. The guard who was last on duty, Porm, informs her that Karak took Odrion without explanation and asked that the next guards not be informed. At this, Fala begins to suspect that her father has betrayed her. If the PCs or Pek take advantage of this and press the issue, she gives in and upgrades the number of soldiers sent to Fitsay.

Soon thereafter, Fala and the PCs are informed that Porm has vanished. Apparently, he was in on the snatching of Odrion.

Success or Failure?

Unless the PCs have totally blown the parley, missing every possible opportunity to sway Fala's loyalties, this episode ends by returning to Fitsay with Fala and some number of renegade soldiers. If the PCs wish to go directly to the Imperial base, Fala and Cardo try to talk them out of it. Even Pek refuses to accompany them. If they still wish to do so, let them (see "The Opening Salvo," below).

If the PCs really did manage to fail, by never approaching Fala or by refusing to speak politely to her, have the information that Odrion is not there be given to them in some other way — an overheard conversation, their own discovery of the guarded hut. Make it clear to them that Karak has taken Odrion for some unknown purpose.

Also make it clear that Odrion is not in the Imperial base, but held by Karak somewhere in the sea. The only possible course of action is to return to Fitsay.

Also, by this point in the adventure the Rebels may come to the conclusion that while Karak is evil, his words are true. And while Cardo is basically good, some of his actions and beliefs are not good for the Sedrians or the Golden Sun. Let the PCs think in these directions, but remind them that now is not a good time to dabble in alien politics when they should be concerned with the Empire.

Cut-Away to Karak and Aban

Read aloud:

INTERIOR: IMPERIAL BASE, COMMANDER ABAN'S QUARTERS. *Aban and a large, fierce-looking Sedrian listen to a breathless messenger.*

"The swimmer is loaded and ready, sir. Your orders?"

"Well, Karak?" *Aban looks to the Sedrian.* "Will you fulfill your bargain and lead us to the Fitsay sun caves?"

Karak nods his assent, his eyes gleaming evilly. "And then I will turn over the Rebel, as we agreed. And then you will give me half the Golden Sun and enough of your weapons for all my soldiers."

Commander Aban nods and turns back to the messenger. "Order the attack to begin at once!" *he says.*

Fade to. . .

The Opening Salvo

On the way back to Fitsay, the Rebels run into the Imperial army just outside the city. Read:

In the murky distance, several lights appear. They're faint at first, then they get brighter and brighter. One light is especially large and bright. As they get nearer, you see the forms of seatroopers jetting forward in perfect formation. Behind them is a Walker-sized vehicle, moving upon repulsors instead of legs. Its beast-like head moves back and forth as though searching for prey, while blaster bolts explode from its forward cannons and boil through the churning sea. The Imperial assault has begun!

Go to episode five to pick up the action.

E

pisode Five Imperial Attack

Summary

The Imperials launch their attack on the city of Fitsay with seatroopers and the dread Swimmer, led to the site by Karak. The Rebels, returning from the renegade settlement, intercept the Imperials just outside the city and the battle is joined. While the battle rages, Karak and his bodyguards sneak into the sun caves (with Mors Odrion still in tow) in preparation for the climactic encounters of episode six.

The Battle Begins

The Rebels see the closing column of seatroopers, bolstered by the deadly Swimmer. The battle begins after the PCs have a brief moment to assess the situation.

If anyone makes a Moderate *command* roll tell them the following (otherwise they see the Swimmer and "a lot" of seatroopers):

- There are 45 seatroopers, armed with blaster spears.
- The seatroopers are divided into five squads of nine troopers each. One squad hangs back to guard the Swimmer's deliberate approach. Two squads range out on either side of the Swimmer to flank and cordon. The remaining two squads range ahead and attack the city with fire support from the Swimmer.

The Imperial Swimmer

The Swimmer is a formidable weapon of war — the underwater equivalent of the AT-AT Walker. The Swimmer propels itself via massive repulsorlift engines. The shell-like armor is designed to withstand crushing pressure and weapons fire. The head-like cockpit pivots to create an illusion of a living beast. The Swimmer has blaster cannons that provide firing arcs in all directions.

AT-AT Swimmer: Crew 5, passengers 40, cargo 600 kg, speed code 3D, body 6D. Weapons: Two modified heavy laser cannon, fire control 2D, damage 6D; two medium blasters, fire control 2D, damage 3D. Skills of crew: repulsorcraft operation 3D+2, gunnery 3D.

The Course of the Battle

What happens depends on the PCs success rate in episode four. Depending on how many renegades they were able to convince Fala to send, read the appropriate section aloud. For your information, the glow referred to is caused by the opening of the Great Shell Dome, for Karak and his select warriors have reached their goal.

If 100 renegades accompany the PCs, read:

The valiant Sedrians swim forward, renegades and Fitsay alike, meeting withering fire from the seatroopers and the Swimmer — but they are not daunted. The first wave of seatroopers falls, and the weakened Sedrian forces fan out to engage and destroy the flankers. Only the Swimmer and its immediate bodyguard continue to advance as the other Imperials close with the remaining sealmen. Cardo leaves you to return to the city and gather the warrior monks. Suddenly the sea glows a dazzling gold, and the Swimmer hesitates. This is the chance you were waiting for. . .

If 40 renegades accompany the PCs, read:

The Sedrians struggle valiantly with the better-armed seatroopers. The flash of sun guns and blasters fill the sea, and the sealmen fall back. If only there were more renegades, the battle would be different! As it is, the first wave of seatroopers has fallen, and the flankers engage the surviving Sedrians while the Swimmer continues to advance. Cardo leaves you to return to the city and gather the warrior monks. Suddenly the sea glows a dazzling gold, and the Swimmer hesitates. This is the chance you were waiting for. . .

If 12 renegades accompany the PCs, read:

The first wave of seatroopers meets your thin line of Sedrians. But the dauntless courage of Fitsay and renegade alike, aided by your skills and battle prowess, turn back the initial attack. Still, the unstoppable

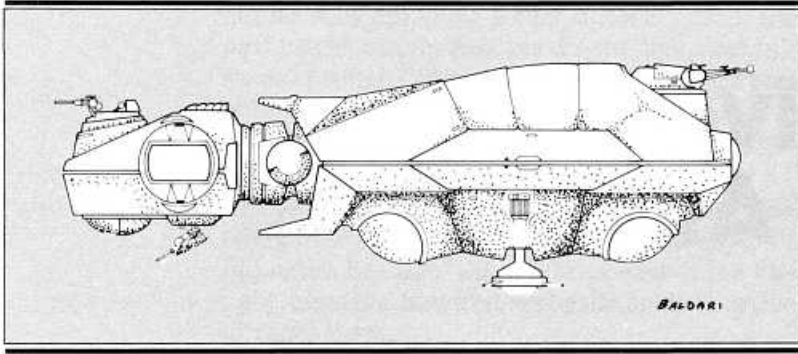

Swimmer continues to advance. Cardo leaves you to return to the city to gather the warrior monks. Suddenly the sea glows a dazzling gold, and the Swimmer hesitates. This is the chance you were waiting for. . .

If no renegades accompany the PCs, read:

The advancing wave of seatroopers is too much for your small party. Cardo orders his warriors to return with him to the city to gather the rest of the monks. Pek remains beside you, watching as the Swimmer continues to advance. Suddenly the sea glows a dazzling gold, and the Swimmer hesitates. This is the chance you were waiting for. . .

Now the PCs get a chance to personally affect the outcome of the battle. Go to "The PCs During the Battle."

The PCs During the Battle

As the battle rages, have the PCs make Moderate *Perception* rolls. Those that succeed realize that the Sedrians should be able to handle the relatively small number of seatroopers, but the Swimmer is beyond their ability to deal with. If the Swimmer is going to be stopped, it will have to be the PCs (and a well-used Force point or two) who do it. When the sea glows gold, the Swimmer hesitates; its crew and computers are blinded. Still, its repulsorlift engines remain operational, as do its weapons! The PCs must make use of the few moments they have before the Swimmer resumes its deadly approach.

Of course, the more renegades the PCs have with them, the easier it is to approach the Swimmer. More renegades mean that more seatroopers are occupied and there is more general confusion.

Before they can reach the Swimmer to try something brave and daring, the PCs must get past the seatroopers that guard the massive vehicle. Adjust the number of seatroopers to match the number of PCs (there are three more seatroopers than PCs, to a maximum of nine). The Swimmer remains inactive for five combat rounds before the crew restarts the repulsorlift engines and gets

the weapons working again. During that time, if the PCs run into trouble with the seatroopers, have a couple of Sedrians appear to assist them.

Once the PCs get past the seatrooper guards (or if a few PCs rush past the seatroopers while their companions mop up the Imperials), go on to "Fighting the Swimmer."

Fighting the Swimmer

The Imperials, locked in combat with the Sedrian warriors, have been stopped outside the city. The Swimmer, its guards engaged or defeated by the PCs, resumes its trek toward Fitsay after a brief pause caused by the surge of power when the Great Shell Dome was opened. Now the Rebels must take the battle to this Imperial death machine, creating a scene reminiscent of Luke's attack on the Walker in *The Empire Strikes Back*.

Remember, hand weapons cannot damage the Swimmer except through an extraordinarily lucky shot. The PCs can swim very close to the vehicle and use grenades and mines, or force their way in through a vulnerable hatch. Use the following bits to build the battle, describing the PCs' progress after each roll, leading to the climactic destruction of the Swimmer!

Adjust the rolls according to the number of renegades the PCs convinced to accompany them to Fitsay. All rolls are Easy if there are 100 renegades; Moderate if there are 40; Difficult if there are 12; and Very Difficult if there are no renegades.

Approaching the Swimmer. Each PC must make a *swimming* roll (adjusted by the number of renegades) to determine how fast they can move up to the Swimmer. If they succeed, that means they moved as quickly as possible and need only make one *hide/sneak* roll each to avoid being spotted. If they failed the *swimming* roll, they moved slowly. Have those PCs make two *hide/sneak* rolls to avoid being spotted.

If anyone fails the *hide/sneak* rolls, the crew spots them and trains the Swimmer's weapons upon them. Go to "The Laser Batteries" bit. If everyone made successful *hide/sneak* rolls, go to "The Repulsor Field" bit.

The Laser Batteries. Any PCs who fail the *hide/sneak* rolls are spotted by the Swimmer's crew. The Swimmer trains its two medium blaster batteries upon those PCs and fires four bolts that boil the surrounding ocean. PCs must make *swimming* rolls to evade the blasts, otherwise roll for damage. When rolling for damage, reduce the PCs Strength by 2D (to a minimum of 1D) and double the damage code of the AT-AT's blasters.

The Repulsor Field. Once the PCs get close to the Swimmer, they run into another obstacle. The

repulsorlift field created by the Swimmer's engines form a barrier of force around the vehicle. This field repels any physical object that comes in contact with it, so the PCs will have to attempt to push their way through it or swim to the top of the AT-AT. To push through the field, PCs must make a successful *Strength* roll. If a PC fails the roll, he or she is repelled by the field and dashed against the ocean floor for 4D damage.

The Access Hatch. Once the PCs reach the Swimmer, they must make a *search* roll to locate an access hatch, then a *security* roll to open it. This gains them entry into the Swimmer, but they must deal with the seatroopers that are within. There are three times as many seatroopers in the immediate area as PCs, but if the PCs attempt to explore the entire vessel they will run into the full complement of 40 seatroopers. Once the immediate seatroopers are dealt with, the PCs must make a Moderate *Technical* roll to find a weak spot in order to destroy the Swimmer. An Easy *demolition* roll and some form of explosive will set a charge that will disable the Imperial ship.

Destroying the Swimmer. If the PCs want, they can locate a weak spot outside the ship. Once they reach the Swimmer, they must make an Easy *search* roll and a Moderate *Technical* roll to find an appropriate place to place an explosive, then set it with a successful Easy *demolitions* roll. Then go to the final bit below.

The Swimmer Explodes. Use your dramatic judgment to determine the effects of various weapons upon discovered weak spots, in case your PCs don't have any explosives. As long as all the appropriate rolls are made, the end result should be the destruction of the Swimmer. Note, this is an excellent opportunity for the use of Force points to win the day. Of course, depending where the PCs set an explosive, they will need to make a quick exit. Use the read aloud below to end the scene:

The Swimmer jerks to a stop and a rumbling can be heard deep inside its impenetrable shell. Bright explosions erupt from various openings, and the deadly Swimmer starts to sink toward the sea bottom, trailing smoke and wisps of fire.

Karak's Actions

During the battle, Karak and his six bodyguards headed directly to the Great Shell Dome. They forced the dome open, filling the sea with golden light. Cardo tried to stop them, but Karak fought back and severely wounded the high priest. Then, with Mors Odrion still in tow, Karak and his men entered the coral caves.

Karak believes that somewhere deep within the caves he will find the secret to unlimited power. And with that power, neither Imperial nor Sedrian can stand against him. In the next episode he finds that power, and only the Rebels from another world can stop him.

The Seige of the Sun Caves

Even though the Swimmer has been destroyed, the battle continues to rage on around the Rebels. Read:

The remaining seatroopers continue to fight the Sedrians as more and more of the city's defenders swim out to join the battle. The muffled din of war is suddenly drowned out by Pek's booming wail. The young Sedrian's eyes grow wide with fear as he turns to you. "Father," he says in a pained voice, "the sun caves!" With that Pek darts off, rocketing through the water toward the Great Shell Dome. Following in Pek's wake, you reach the open dome. Lying at the base of the dome, bathed in golden rays, is Cardo. The wound slashed in his chest would have been instantly fatal had not he been so close to the caves. Even so, you can tell that it may still prove to be the end of the high priest.

Pek races to his father's side. Trembling in his son's embrace, Cardo manages a few weak syllables before falling unconscious. "Karak... the caves..." Rage twists the young Sedrian's features, and his booming voice fills the watery depths. "Karak!"

Proceed to episode six.

E

pisode Six Into the Sun Caves

Summary

The Rebels, Pek, Fala, and Re kara must enter the sun caves and hunt down the evil Karak. But it won't be as easy as they think. Not only does Karak have six bodyguards and a fearsome razort, but the Golden Sun itself fights against the intruders. Plus, by the time they reach Karak, the evil renegade has discovered the power he sought.

If the PCs succeed, they stop Karak, rescue Odrion, and free the Golden Sun. If they fail, the powers of the Golden Sun and Mors Odrion's life could be lost forever.

At the Cave Entrance

The Rebels and their companions reach the entrance of the coral caves and find Cardo, wounded and dying. Waves of anger and fear flow through the Force, reflecting the feelings of the sun coral. Re kara urges the PCs to move, to "expell the dark ones from the caves of light."

But Pek requests aid for his father first. A Difficult *medicine* roll and a medpac will stabilize Cardo's condition. Then Pek grimly turns to enter the caves.

Fala warns that Karak is usually accompanied by six of his most trusted bodyguards, powerful warriors all, and his razort pet, Tooch. Re kara begs everyone to have care when firing weapons as stray shots may harm the living coral. Then Pek and Fala lead the way inside.

Note: A Force-using PC plays a significant role in the upcoming events, but if there are no Force users the coral chooses the PC with the highest Perception code to be its champion (see "The Final Battle").

Map of the Sun Caves

The map of the sun caves, located in the pullout, is for your eyes only. Showing it to the players ruins some of the surprises this episode offers.

Remember, these caves are formed by the coral itself — they are actual hollows within the living reef. Bits of crystalized coral lie scattered throughout the chambers. These energized chunks

can be used to power sun guns, as well as to enhance Force abilities (see "The Final Battle").

Note, the coral is frightened and confused. In this state, it considers everyone an invader. The coral walls scrape and pull at passing characters, passages seal up, and waves of emotion pound into Force-sensitive characters.

These waves represent the Golden Sun's use of the Force. As the PCs enter the specially marked chambers they must each make a *survival* roll. The first roll's difficulty is Very Easy, but it increases by one level each time. The effect of a failed roll is to lower the character's attributes by 1D as though he were wounded. The effect of a second failure is to incapacitate the character. Force users are somewhat immune to this effect. While they must make *survival* rolls, they never become incapacitated.

When the PCs enter the caves, read:

The Golden Sun glow is less intense inside the caves, but no less awe-inspiring. The living walls are hard and stoney, and the interior projects an eerie, otherworldly atmosphere.

Use the descriptions below as the PCs wander the caves. Note, Karak has placed his six renegades and the razort at various locations. Their job is to slow the PCs long enough for him to find the power source he craves.

1. Entrance Hall. The entrance hall is wide and bright. There is a large room to the left, and a narrow rising passage to the right (it requires a Moderate *search* roll to find) hidden among a tumble of rocks. A wave of power hits the PCs here. Everyone must make *survival* rolls.

2. Divided Hall. This high-roofed chamber, about 40 meters in diameter, has a column of coral rising from the center of the floor all the way to the ceiling. There are large openings in the far wall. A Moderate *streetwise* roll suggests to the PCs that this would be a good place for an ambush — and indeed, Karak's bodyguard Dragob waits on the other side of the column. When a character comes

around the column, or when Dragob hears talk which leads him to believe the PCs are on to him, he swims out and takes a triple-hasted shot (plus two hastes for surprise if appropriate) with his spear gun. Then he turns to flee, but both exits have sealed. He fights to the death.

When the fight is over, the PCs find their way blocked by the coral. Rekara takes the now-glowing chunk of coral she has been carrying and touches it to the column. There is a blinding flash of light, and the chunk becomes one with the coral. "Please," she asks, "help us." And with that the passages open.

Dragob: Use the same statistics as warrior monks with the following changes: Spear gun 4D+2, melee weapon 5D.

3. Huge Chamber. This huge chamber is empty. On the far wall a tumble of rock and coral has fallen from the wall. Six meters off the ground a man-sized hole provides the only other exit from this chamber. Hiding in the tumble of rocks is Spodan, another of Karak's henchmen. Spodan waits until the last character has gone up to the hole in the wall, swims up and grapples the character (trying to prevent any sound) and administers a sting from a spiny urchin. After subduing his victim he makes his way to the crossroads. If the PCs search the rocks, one of them comes upon Spodan, who attacks with the urchin even if it means his own defeat.

Spodan: Use the same statistics as priests with the following changes; brawling 5D, climb/jump 5D. The urchin contains enough poison for two applications and does 4D+2 stun damage.

4. Narrow Passage. This winding passage is wide enough for two abreast. There is nothing in the passage, but another *survival* roll must be made here.

5. Anemone Farm. A long, tubular chamber filled with sea anemones, provides a beautiful vista. An *Easy survival* roll also lets the PCs know it is a deadly vista — these are a variety of very poisonous anemone.

Glish is here, pressed against the wall. When he hears the characters coming, he steps out and fires a double-hasted (plus two hastes for surprise where appropriate) shot with his spear gun. Then he flees down the length of the chamber on a predetermined safe route through the anemones, to the down-sloping passage into Room #2.

If the PCs follow, it takes a *Moderate Perception* roll to notice the safe path, and an *Easy Dexterity* roll to follow it. Glish fires a sun gun at the lead character just before going down the slope. If a character fails the *Dexterity* roll or is hit by the sun gun while crossing the farm, he or she falls

into the anemones. Make a 5D roll vs. the character's *stamina*. If the sting roll is greater than the *stamina* roll, the character is wounded (regardless of the multiple).

Glish: Use the same statistics as warrior monks with the following changes; speargun 4D+1, swimming 7D.

6. Seaweed Room. This small round room has a clump of seaweed waving in the center. There are no obvious exits from this chamber, but under the seaweed is a tunnel (an *Easy search* roll). The very narrow tunnel is only wide enough for one abreast.

A *Very Difficult search* or *sense* roll detects a presence in the passage. Otherwise, after the last



character in line enters the tunnel, Karak's razort attacks.

Razorts are otter-like water creatures with a vicious nature and fearsome visage. Long fangs, armored joints, and a razor-sharp tail combine with deadly quickness to create a much-feared predator. Somehow, Karak has managed to tame one. Tooch will do anything for Karak.

Tooch attacks twice in one round — once with a bite and once with his razor-tail. Because of the razort's quickness, the two attacks count as one action. When describing Tooch's attack, remember those scenes of underwater combat with alligators from the *Tarzan* movies and you can't go too far wrong. The chosen victim finds it impossible to use ranged weapons against Tooch, since his attacks bring him right on top of a character.

Tooch: DEX 5D, PER 3D, STR 4D+2. Bite damage 3D+1, razor tail damage 5D.

7. Wide Hall. This chamber branches off from the divided hall. Force users feel as though they are being spoken to. A Moderate *sense* roll gives the Force user a warning that three "evil ones" wait up ahead, negating surprise by any of the three waiting in the halls. A *survival* roll must be made while in this chamber as well.

8. Small Chamber. This small room at the end of the tunnel is about 15 meters in diameter. It appears perfectly normal and empty to the casual eye. An Easy *search* roll reveals the hidden passage on the far wall. A Difficult *streetwise* roll hints to the PCs that the hidden passage was a little too easy to find — there might be a trap.

9. Secret Chamber. This secret chamber must be entered by pressing through the coral boundary. Karak has set a spear gun to discharge when the coral is moved. A Moderate *security* roll finds the trap, and a Moderate *Dexterity* roll disables it.

10. Crossroads. This intersection between the halls is quiet and still. Karak's men wait just out of sight in the halls.

11. Hall #1. This sloping passage is lined with glowing chunks of crystal coral. Karak's man Burborok waits here. He calls from out of sight to issue a challenge to Pek. This is actually a trick to allow the others time to launch an attack from the rear. A Difficult *command* roll can prevent Pek from accepting the challenge.

Burborok: Use the same statistics as priest with the following changes; brawl and melee parry 5D, melee 5D, brawl 5D.

12. Hall #2. K'hondo, another renegade, hides amid the tumbles of rock and coral. He uses only a sun gun, as he is pacifistic. He fires the sun gun

multiple times at one character, hoping to knock that character unconscious.

K'hondo: Use the same statistics as priests with the following changes; sun gun 6D.

13. Hall #3. Porm waits here behind a hastily piled palisade of rock and coral. He has an Imperial blaster which was given to Karak. He also has one grenade which he will use when wounded or when he is about to be overrun. A *survival* roll must be made here.

Porm: Use the same statistics as renegades with the following changes; blaster 2D, brawling parry 4D, melee and melee parry 5D.

14. Room #1. The first of three chambers used to place injured Sedrians for overnight healing of grave wounds. These rooms contain some of the most powerful concentrations of the living polyps in all the caves. While in its agitated state, the Golden Sun will not preform its healing function.

15. Room #2. Another healing chamber, this room serves as the site of Karak's last stand. Go to "The Final Battle" below.

16. Room #3. Yet another healing room. However, as the PCs approach, they notice a murky quality to the water. A Difficult *planetary systems* roll reminds PCs of a gas-emitting creature on the water-world of Ashash — it might not be safe to enter the chamber. And sure enough, Porm has thrown a stinkfish into the chamber; the poison overcomes any character who enters the room unless he makes a Moderate *stamina* roll. Failing the roll knocks the character out.

17. Great Chamber. This cavern is the largest in the sun caves. At the far end is a great jumble of huge boulders known as the Throne Rocks. It is here that Cardo and Pek go to meditate on the mysteries of Golden Sun. Now, the chamber will attack any invaders unless they convince the coral they are friends. It attacks by firing sun beams from the walls to stun intruders. A Moderate *sense* roll allows a Force-using PC to talk with the coral.

The Final Battle

At some point the PCs must face Karak himself, one of the most powerful Sedrians alive. He is deadly with many different weapons and excels in hand-to-hand combat. He keeps Mors Odrion tied up and nearby, ready to use as a shield if the need arises.

The final battle takes place in Room #2. It is within this healing chamber that Karak finally connects with the power he craves. The chamber now reeks of the Dark Side, and the golden glow has dulled and turned evil. Karak, holding hand-

fuls of crystal coral, waits to test his new-found abilities upon the aliens that aid Pek.

Karak has perverted the integrity of the Golden Sun. He has overwhelmed this section of coral, using his will to dominate and control the frightened entity. Refer to the portion of Karak's character card that describes his Dark Side powers when running this battle. Read:

The chamber ahead is darker than the rest of the caves. The coral walls seem to be losing light, their golden glow fading. There is something not right here. You feel cold, death. Then you hear an evil voice. "Come weak ones! Come approach Karak and bow to his power!"

Karak, now full of the power of the Golden Sun, is a deadly opponent. He glows with energy, getting brighter with each passing moment as the coral dulls. Let the battle be dramatic and difficult as the PCs try to find some weakness to exploit. While certain attacks will affect Karak, the PCs' best hope lies in the coral choosing a champion to defeat the evil one.

Karak's Tactics: Karak dives from wall to wall, effortlessly holding Odrion before him. This makes him harder to hit (+10 difficulty). He fires bolts of energy from the crystals he clasps in his hand, but this energy has been tainted. It causes actual damage, not stun damage. He deflects blaster bolts with the crystal rocks, as well as dissipating energy directed at him. His goal is to destroy the Rebels and their Sedrian friends so that he can subjugate the rest of the Golden Sun.

While the battle proceeds, Rekara, Pek, and Fala discover that they cannot enter the one-time healing chamber. The screams of the imprisoned coral is just too much for them to bear. Force-using PCs experience discomfort, but can enter the room. They are, however, constantly called by the untainted Golden Sun, although they cannot understand what is being said.

If a Force-using PC asks to try to contact the Golden Sun, let him make a Moderate *sense* roll. He hears a thousand singing voices calling for peace, harmony, and a return of joy. He hears their dream of togetherness for Sedri, and hears a request to join with them in the sun. Rekara, Pek and Fala, apparently hearing the same song, grasp hands and touch the coral walls. They are caught up in glowing shafts of light, extending hands for the PC to join them. If there are no Force-using Rebels, the Golden Sun calls to the PC with the



highest Perception code. That PC sees a vision. Read:

The golden song becomes louder, more intense. Your vision is filled with bright colors and a warm glow surrounds you. Thousands of voices, sad yet full of purpose, sing to you of a world bound together by peace and sharing. Then the colors shift and you see the coral reef before you, full of power and energy. Waves of fear wash through you, followed by waves of commitment. Then the coral explodes, releasing its energy in waves of happiness and sharing. Then the vision fades. You still hold hands with Pek and the others, somewhere within the coral reef. Nearby, you hear the sound of battle as Karak continues his unending attack.

The PCs should get the hint that the only way to defeat Karak is to eliminate his source of power. The way to do this is to scatter the coral, dissipating its energy throughout the sea. If the PC doesn't realize this, have Rekara suggest it. Pek refuses, unwilling to lose the Sedrians' source of



SUBLEVEL A

- SOURCEFILE: IGB/A.INT
- SUBFILE//SCHEMA: - 1
- SCALE SPEC 0.84//SCHEMATIC

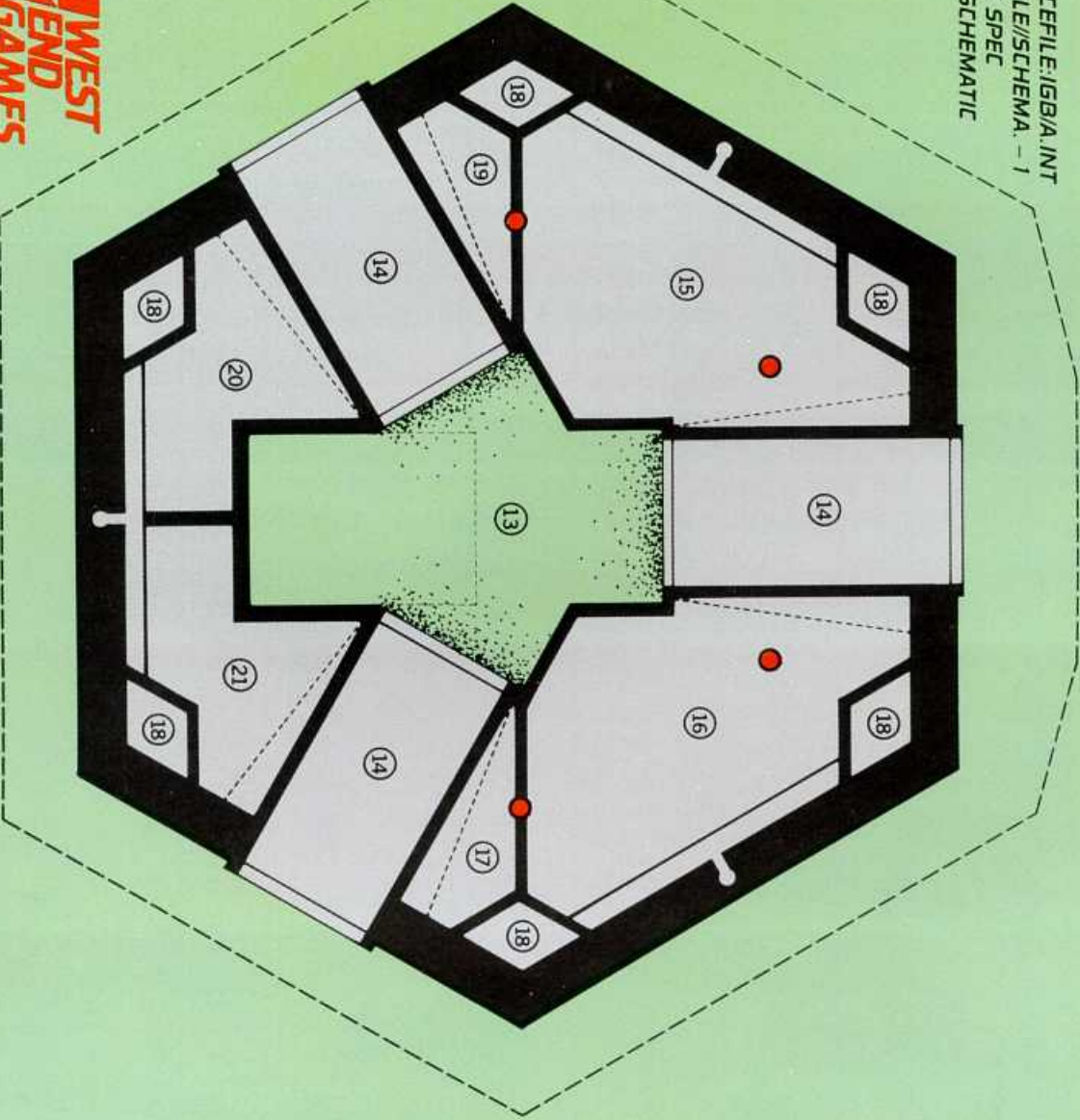

- SOURCEFILE: IGB/A.INT
- SUBFILE//SCHEMA: 7
- SCALE SPEC 0.84//SCHEMATIC





EXTERIOR AERIAL VIEW

- SOURCEFILE: 1GB/A_EXT
- SUBFILE//PLAN.X
- SCALE SPEC 0.84//SCHEMATIC

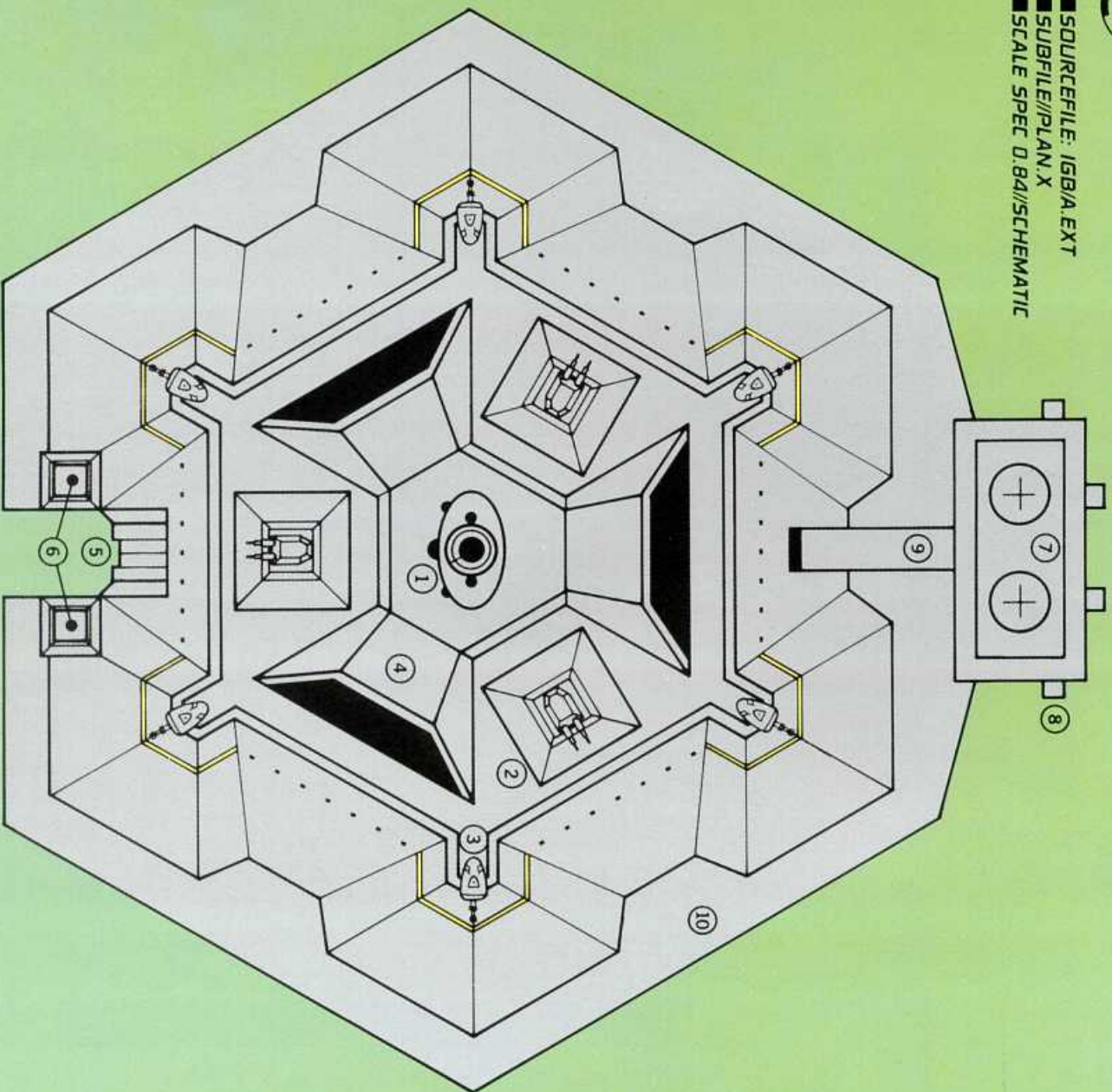

STAR

Battle for the

For use with Star Wars

Imperial Garrison

- DATA SEARCH
- PRG40017
- SOURCEFILE: 1GB/A
- FILEPATH 8809/23P//1GB.INL//SC
- SCALE SPEC 0.93//SIMULATION

FRONT ELEVATION

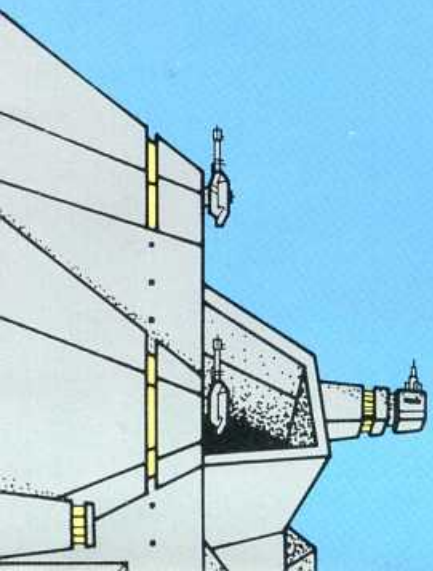

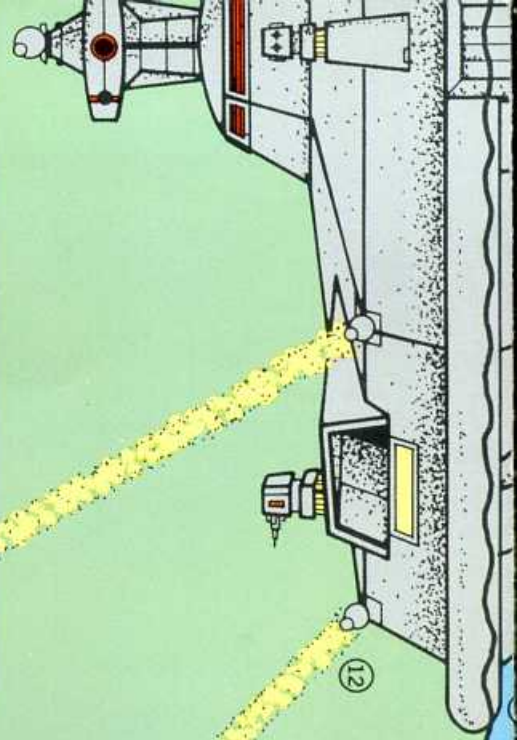

LEVEL 7

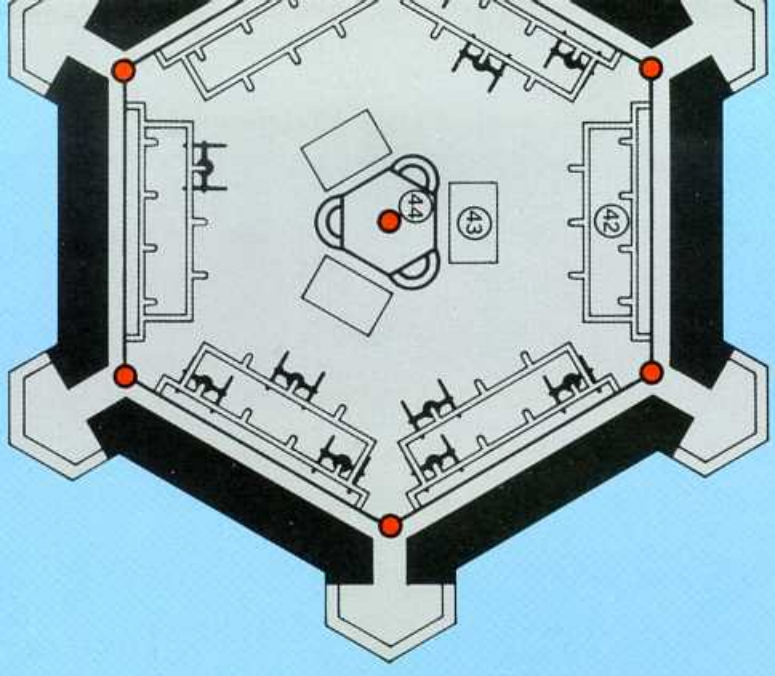

LEVEL 6

- SOURCEFILE: 1GB/A.INT
- SUBFILE//SCHEMA.5
- SCALE SPEC
- 0.84//SCHEMATIC

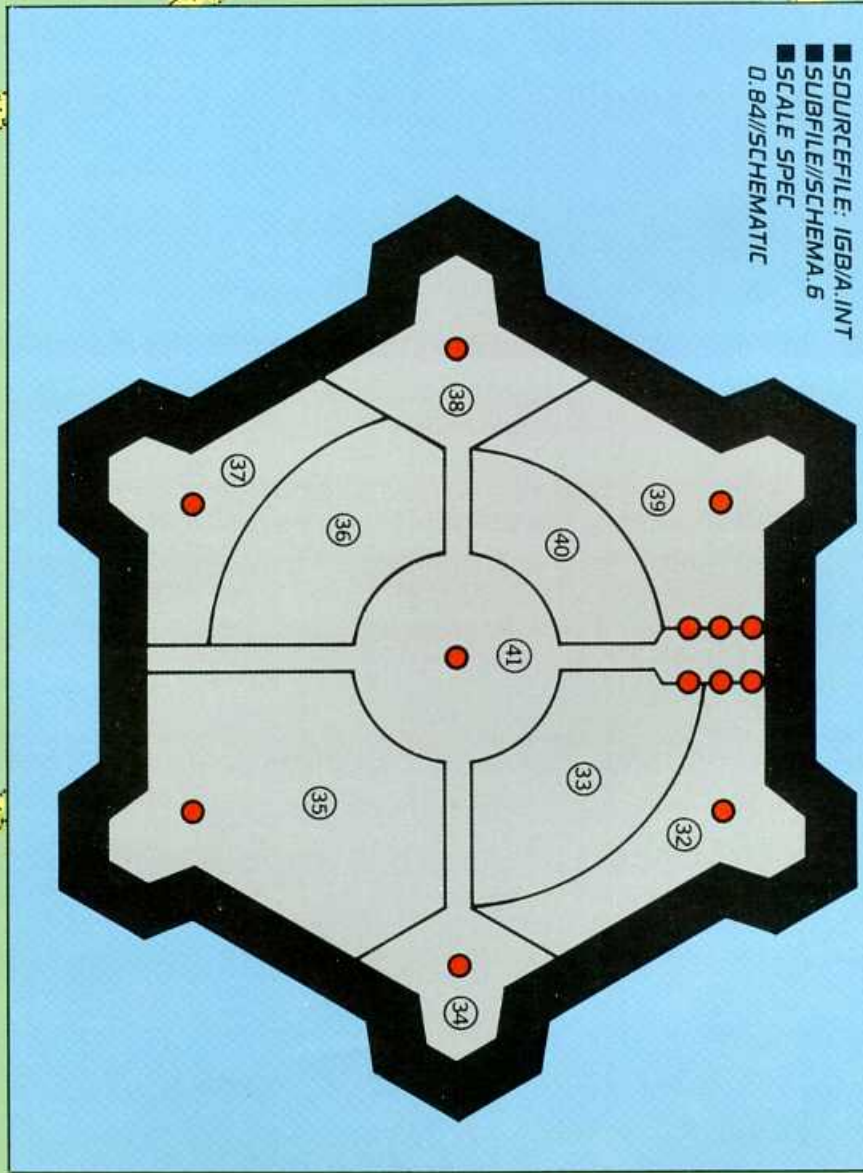

- SYS.COM.RET
- 923//09...2//988/END

Steve

WARPS

Golden Sun

The Roleplaying Game

Golden Sun Base/Aquatic



LEVELS 1-5

- SOURCEFILE: IGB/A.INT
- SUBFILE//SCHEMA.1..5
- SCALE SPEC
- 0:84//SCHEMATIC

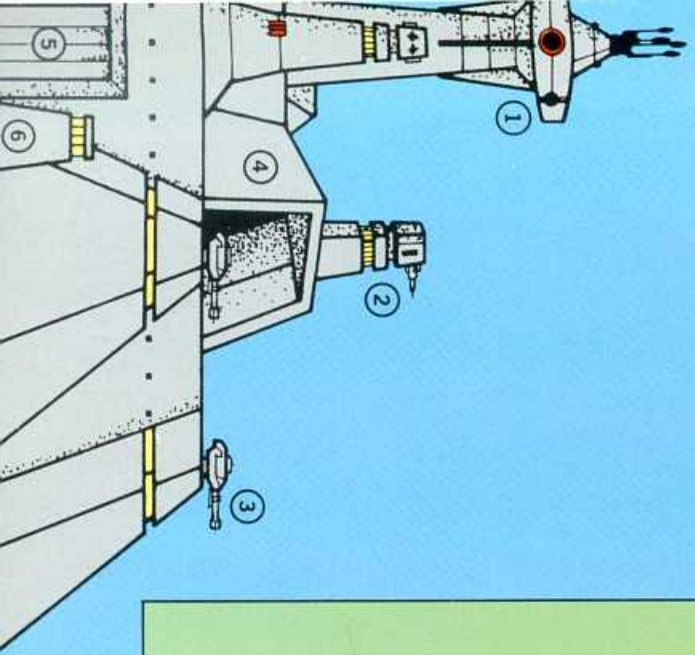
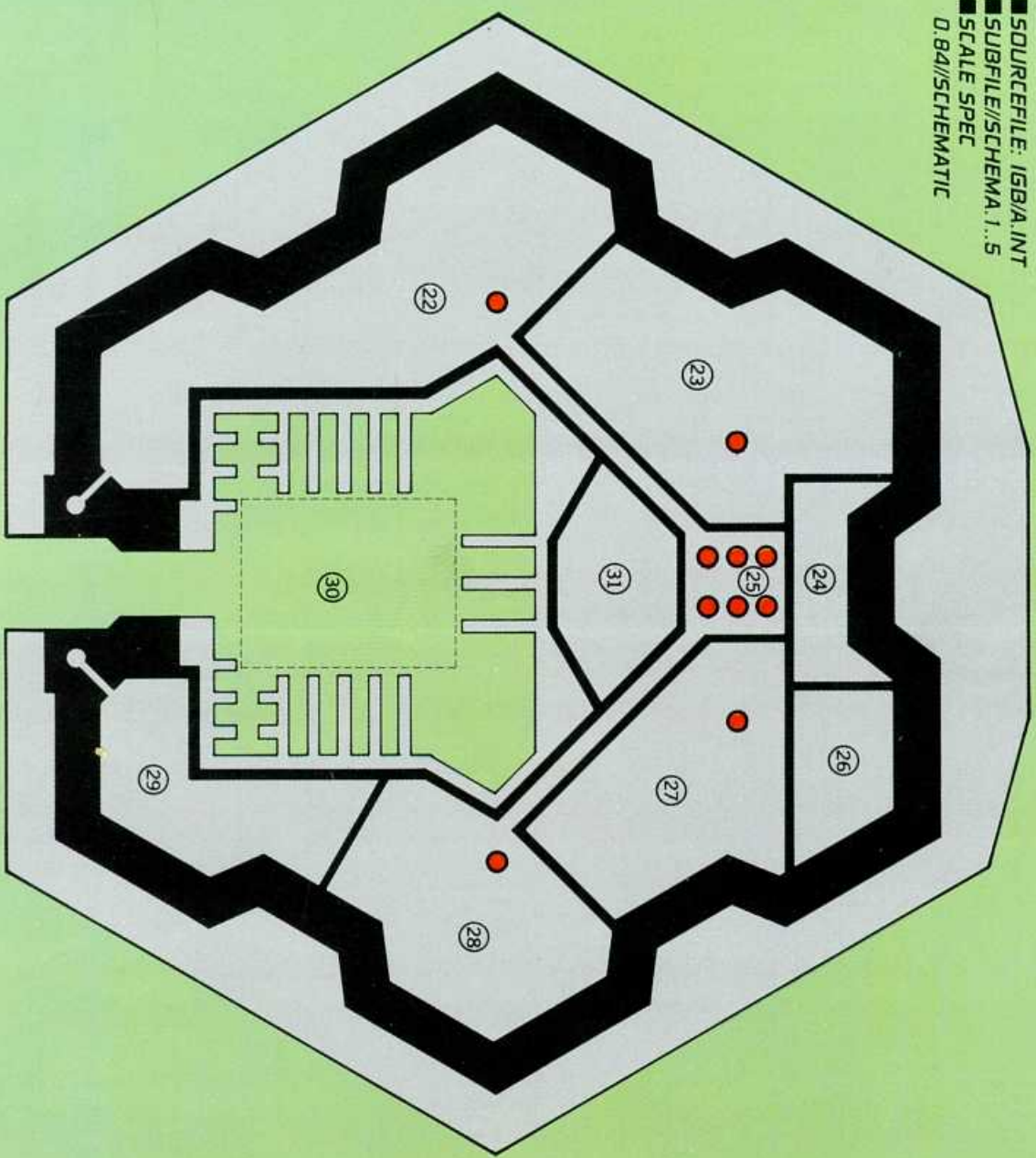

STAR WARS®

Battle for the Golden Sun

by Douglas Kaufman

A navigational accident has led the Empire to the mysterious and legendary water world of Sedri. Rebel spy networks carry troubling tales back to Alliance High Command, rumors that Sedri holds the secret of the Golden Sun — a secret that could give the Empire the power to crush the Rebellion once and for all!

An Alliance dignitary, young and impetuous, disappeared while checking into these disturbing rumors. Now a special team of Rebel agents volunteer to undertake a desperate mission. Guided by a half-sane Mon Calamari, they must make their way to Sedri, locate the missing dignitary, avoid Imperial entanglements, and solve the mystery of the Golden Sun.

If the rumors prove even partially true, then this band of Rebels is all that stands between the Empire and total control of the Galaxy...



40-page booklet features:

- An exciting script with a part for each player that brings their characters to life and plunges them right into the action.
- Detailed descriptions and maps of an underwater village and the mysterious Sun Caves of Sedri.
- Background information on a new race of sea dwellers from the planet Sedri.
- A pull-out section full of colorful non-player character templates for an added dimension in roleplaying excitement.

Also includes:

- A poster-size, full-color map of an Imperial Sea Garrison — a complete base with descriptions of important areas, special equipment, and undersea stormtroopers.
- Extensive guidelines to help gamemasters make their adventures fast-moving, challenging, and fun.

A complete adventure for *Star Wars: The Roleplaying Game*. For gamemaster and one or more players.



West End Games
RD 3 Box 2345
Honesdale, PA 18431
40017

For ages 12 and up.

© , TM & © 1988 Lucasfilm Ltd. (LFL).
All Rights Reserved. Trademarks of LFL
used by West End Games, Inc., under
authorization.

ISBN 0-87431-103-9



0 18874 40017 8